

Toxics Use Reduction to Achieve Enhanced Pollution Prevention Success

August 20, 2015

Massachusetts Toxics Use Reduction Institute
University of Massachusetts Lowell
600 Suffolk St, Lowell, MA 01854
www.turi.org



Table of Contents

1	Introduction to Toxics Use Reduction	1
1.1	Why Reduce Toxic Chemicals?	1
1.1.1	Potential Health Risks from Toxic Chemical Exposures.....	1
1.1.2	Chemicals in the Workplace	1
1.2	What is Toxics Use Reduction?	2
1.2.1	Pollution Prevention vs. Pollution Control	2
1.2.2	Pollution Prevention Hierarchy.....	3
1.3	Historical Context for TUR.....	4
1.3.1	1970s – Pollution Control and Cleanup.....	4
1.3.2	1980s – Crisis Management, Liability & Toxics.....	4
1.3.3	1990s – Pollution Prevention.....	5
1.3.4	2000s – Emphasis on Management Systems and Higher Hazard Substances ...	7
1.4	The Six TUR Techniques.....	7
1.5	TUR and Planning.....	8
1.5.1	Continuous Improvement in TUR Planning	8
1.5.2	How can continual improvement be built into the planning process?.....	9
2	Process Characterization: Process Mapping	9
2.1	Introduction to Process Characterization.....	9
2.2	Process Mapping	10
2.3	Chemical Pathway Analysis.....	12
2.4	Defining the Product	14
2.5	Defining the Unit of Product.....	14
1.6	Using Existing Process Maps.....	16
2.7	Conducting a Walk-Around	17
3	Process Characterization: Materials Accounting	18
3.1	Introduction to Materials Accounting	18
3.2	Understanding Materials Accounting.....	18
3.3	Understanding Byproduct and Emissions	19
3.4	Materials Accounting Techniques.....	21
3.4.1	Defining the System.....	21
3.4.2	Accounting for Accumulation.....	23
3.4.3	Solving Simultaneous Equations	24
3.4.4	Materials Accounting with Mixtures	26
3.4.5	Materials Accounting with Concentrations	27

3.5	Gathering Data	28
3.5.1	Materials Procurement	30
3.5.2	Storage and Handling.....	30
3.5.3	Materials Use	30
3.5.4	Integral Recycling (Reuse)	31
3.5.5	Materials as Byproducts and Emissions	31
3.5.6	Materials as Products	32
3.6	Chemical Tracking	33
4	Identifying TUR Opportunities	36
4.1	Identifying Options	36
4.1.1	Brainstorming TUR Options.....	36
4.1.2	Information Sources for Alternatives.....	38
4.2	The Six TUR Techniques.....	39
4.2.1	Input Substitution.....	40
4.2.2	Product Reformulation.....	42
4.2.3	Production Unit Redesign or Modification.....	42
4.2.4	Production Unit Modernization	43
4.2.5	Improved Operation and Maintenance.....	44
4.2.6	Recycling	47
4.3	Being Systematic.....	48
5	TUR Options Evaluation and Alternatives Assessment	48
5.1	Introduction to TUR Options Evaluation	49
5.2	Screening TUR Options	49
5.2.1	Technical Screening.....	50
5.2.2	Economic Screening	51
5.2.3	EH&S Screening.....	51
5.3	Evaluating TUR Options.....	52
5.3.1	Technical Evaluation	52
5.3.2	EH&S Evaluation.....	54
5.3.3	Economic Evaluation.....	57
5.4	Deciding Whether to Implement a TUR Option	59
5.4.1	Less-Tangible Factors to Consider	60
5.4.2	Potential Financial Liability.....	62
5.4.3	Pilot Testing TUR Options	63
5.5	Making the Business Case for Implementing TUR Options.....	63

1 Introduction to Toxics Use Reduction

Objectives: After this module participants will be able to:

- Discuss the evolution and context for toxics use reduction (TUR)
- Understand the central role of planning in achieving TUR
- Differentiate between TUR, pollution prevention and pollution control, and understand why the differences are important
- List the six TUR techniques, and discuss examples of how they can be implemented

1.1 Why Reduce Toxic Chemicals?

1.1.1 Potential Health Risks from Toxic Chemical Exposures

Toxic chemicals used in the workplace have resulted in serious health impacts on workers, the ecosystem and our water, air and land environments. Toxic chemical exposure is not merely associated with chemical use in manufacturing. A few examples of other exposure scenarios include:

- Dry cleaning shops have used perchloroethylene, a carcinogen and reproductive and developmental toxicant, for years. Perchloroethylene releases from these operations have resulted in wide-scale contamination of drinking water resources.
- Methylene chloride has been used in a wide variety of industrial and non-industrial activities – in vapor degreasers, as a blowing agent for urethane foam, a solvent carrier for adhesives, and for paint stripping during refinishing of autos, furniture and other household products. At least 14 workers have died since 2000 just as a result of using methylene chloride-based strippers during refinishing of bathtubs.
- Workers in beauty salons are often exposed to an array of hazardous chemicals – including toluene, styrene, di-butyl phthalate and formaldehyde – that can cause everything from skin rashes and headaches to cancer and liver damage.

1.1.2 Chemicals in the Workplace

Chemical production and use in the U.S. economy has expanded dramatically for decades. The Bureau of Labor Statistics estimates over a \$1.2 trillion increase in the value of U.S. chemical output between 2000-

Potential environmental and health risks

Serious illnesses and early mortality from occupational exposure to hazardous chemicals well documented

Environmental damage resulting in impacts to the ecosystem, drinking and surface waters, and air.



Source: EPA, Environmental Health Perspectives

Hazardous chemicals used routinely in workplace



Source: EPA, Environmental Health Perspectives

Increasing numbers, volumes of chemicals in commerce

- Volume of chemical production rapidly increasing—\$1.2 trillion increase in value of U.S. chemical output between 2000-2020
- Number of chemicals and chemical products increasing—24,000 chemicals added to EPA's TSCA inventory since 1982
- Many chemicals manufactured/used in workplace **not adequately tested** for health impacts

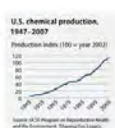

Source: U.S. Department of Commerce, Bureau of Economic Analysis, Chemical Industry Survey

2020. In addition, the range and diversity of chemical products is expanding as companies innovate to meet commercial opportunities or requirements.

The strength of U.S. chemical production obviously provides major benefits to the economy in general. It is important to recognize, however, the hazards of chemicals for those working with them and for the environment. For some of the most toxic of these chemicals, the only adequate protection is a transition to safer alternatives.

1.2 What is Toxics Use Reduction?

Toxics use reduction (TUR) is a fundamental form of **pollution prevention** that focuses on reducing the use of toxic chemicals and reducing the generation of toxic wastes in the manufacturing process *prior to* recycling, treatment or disposal. TUR does not include the management or treatment of wastes once they are produced.

TUR means changing the way toxic chemicals are manufactured, processed, or otherwise used, as well as reducing the amount of byproduct (non-product output) generated. TUR is measured in a production process per unit of product produced, so that the goal of TUR is to protect the environment and workers without compromising productivity.

TUR is one of several forms of pollution prevention (P2), and the two terms are often used interchangeably in this course. The goals of P2 and TUR are identical: to reduce waste at the source, prior to treatment, control or disposal. TUR is simply a specific type of pollution prevention that focuses on toxic chemicals; P2 encompasses all resources such as energy and non-hazardous chemicals. Nevertheless, as you will learn in this course, when implemented properly, the TUR planning process greatly enhances productivity and conserves all types of resources, such as water, raw materials, and energy. In fact, resource conservation and energy conservation have been part of the TURA program since TURA was amended 2006.

1.2.1 Pollution Prevention vs. Pollution Control

It is important to understand the distinction between pollution prevention and pollution control in order to successfully develop and implement a TUR Plan and to comply with TURA. **Pollution control** deals with waste *after* it has been generated, whereas Pollution Prevention attempts to *avoid generating* waste in the first place. Any action taken after waste has been generated, including recycling, treatment, concentration, or dilution is not considered P2.

Pollution prevention differs from pollution control in several important ways:

1. P2 is about reducing or eliminating the use of toxic chemicals or the generation of hazardous byproducts at, or prior to production rather

Source Reduction

- Reducing the hazards present in products and processes is the most efficient means of reducing risk to workers, the environment and consumers
- Source Reduction includes
 - Pollution prevention
 - Increased process efficiency
 - Resource conservation
 - Toxics use reduction

What is Toxics Use Reduction?

In-plant changes in production processes or raw materials that **reduce, avoid, or eliminate the use** of toxic or hazardous substances or generation of hazardous byproducts **per unit of product**, so as to **reduce risks to the health of workers, consumers, or the environment**.

Definition of TUR: Key Points

- In-plant changes
- Reduce, avoid, or eliminate the use of toxic or hazardous substances or generation of hazardous byproducts
- Per unit of product
- Reduce overall risks to workers, consumers, and the environment
- Without shifting risks
- Through TUR techniques

P2 and TUR



Forms of Pollution Control



than limiting the discharge of wastes at the property line of an industrial facility.

2. P2 is about planning and goal setting with an eye toward the efficient use of materials in production rather than about regulations, permits and licenses, which may take time from designing efficient production systems.
3. P2 is about continuous improvement rather than about merely compliance with environmental regulations. It encourages firms to set reasonable goals, and after meeting them, to reset the goals for further improvements.
4. P2 is about real reductions of toxic chemical use and toxic chemical waste, rather than shifting the risk of chemical exposure between population groups (e.g. workers or consumers) or environmental media (air, water and soil).

P2 is about incorporating goals into an effective management system that includes:

- Defining responsibilities
- Providing resources
- Taking corrective actions if goals are not met
- Reviewing periodically
- Managing changes or new developments

1.2.2 Pollution Prevention Hierarchy

In 1990, with the passage of the Pollution Prevention Act, the U.S. Environmental Protection Agency (EPA) developed a formal definition of pollution prevention and a strategy for making P2 a national priority. The strategy established a hierarchy to guide national policy:

- Pollution should be *prevented or reduced* at the source whenever feasible.
- Pollution that cannot be prevented should be recycled in an environmentally safe manner whenever feasible.
- Pollution that cannot be prevented or recycled should be treated in an environmentally safe manner whenever feasible.
- Disposal or other release into the environment should be employed **only as a last resort** and should be conducted in an environmentally safe manner.¹

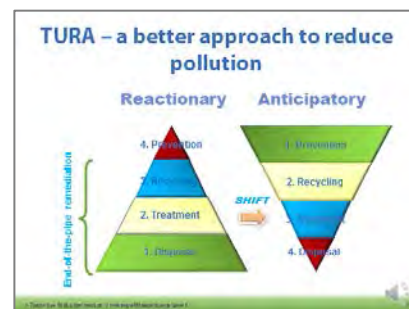

¹ (Source: Henry F. Habicht II, Memorandum: EPA Definition of Pollution Prevention. U.S. Environmental Protection Agency, May 28, 1992.)

1.3 Historical Context for TUR

To understand the definition and the significance of TUR, it is useful to know how it fits in the historical context of environmental policy and regulation in the United States. As a concept and as a tool for environmental policy-making, TUR did not materialize overnight, but rather evolved as a response to the inherent limitations and weaknesses of the predominant environmental protection policies that took root in the early 1970s.

1.3.1 1970s – Pollution Control and Cleanup

The landmark pieces of legislation passed in the early 1970s were aggressive in their mission to clean up and control the most visible types of air and water pollution. The gains were notable. Air quality improved dramatically through the use of catalytic converters, and waterways gradually started coming back from the grave through greatly expanded sewage treatment programs.

However, the emphasis of the legislation in the 1970s was on **pollution control** – managing substances that had already been sacrificed as waste. The laws prescribed end-of-pipe or end-of-stack technologies such as scrubbers, and regulated permissible amounts of emissions and discharges. Industries approached the economical and technical limits of waste treatment, because the costs of removing pollutants from a waste stream increase exponentially as greater efficiencies are achieved.

Moreover, the legislation of the 1970s did not focus earnestly on the less visible forms of pollution, namely hazardous waste. In the 40 years following the Second World War, the amount of hazardous waste generated in the United States increased from about one billion pounds per year to almost 22 billion pounds per year. Despite an EPA policy in 1976 that made reducing hazardous waste at the source the agency's highest priority, federal and state agencies spent about \$16 billion a year on hazardous waste control efforts, but only \$4 million on source reduction of hazardous waste.

1.3.2 1980s – Crisis Management, Liability & Toxics

Several high-profile incidents in the 1980s focused national attention on toxics. In response, Superfund was enacted to clean up America's most hazardous waste sites. But the enormous expense of hazardous waste cleanup, and the complicated liability issues associated with it greatly inhibited actual environmental progress. As a nation, we were learning that wastes that are thrown away do not go away, and indeed, there is no "away" with hazardous wastes. Pollution treatment and control generally did not get rid of pollutants, but simply shifted them from one environmental medium to another. For example, scrubbers – air pollution treatment devices used by power plants – are relatively effective at stripping sulfur from air emissions, but the sulfur is simply transferred to the land in the form of a hazardous slurry that must be disposed.

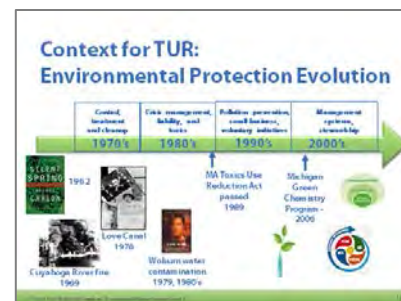
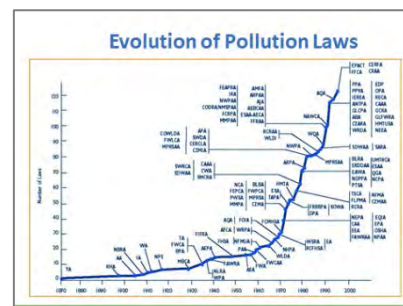

In 1989 the EPA released the first reports from the Toxics Release Inventory (TRI), a national survey of industrial chemical releases established under the Emergency Planning and Community Right to Know Act of 1986. The data revealed a much larger volume of pollutants released to the environment than any of the previous estimates. One important point was becoming increasingly clear: *it is better to prevent waste in the first place than to clean it up later.*

1.3.3 1990s – Pollution Prevention

By 1990, the concept of pollution prevention was catching on. Congress passed the Pollution Prevention Act (P2 Act) in 1990, which established an administrative base and information-tracking capacity for pollution prevention at the EPA. The P2 Act also provided funding for states to develop their own pollution prevention programs.

In 1989, Massachusetts passed the Toxics Use Reduction Act (TURA), a statute intended to promote safer and cleaner production, and enhance the economic viability of Massachusetts firms. TURA was the first law of its kind in the United States. Whereas traditional environmental regulations focused on controlling emissions and releases of pollutants to the environment, TURA promoted preventive strategies. Toxics use reduction (TUR) was predicated on the simple realization that it is better to avoid generating pollution in the first place than to try to treat it or manage it later.

In 1989, this was a bold, new way of thinking. It represented a fundamental shift in policy-making since 1970, when environmental regulations focused on specific pollutants *after* they were released to the environment.

By 1996, every state in the U.S. had at least one pollution prevention program to assist companies in reducing waste. Most P2 Programs provided outreach and developed technical resources to help companies reduce waste at the source. By the end of the 1990s, an impressive amount of useful pollution prevention information had been developed, most of which is accessible on the Internet.

The Advent of TUR – The term *toxics use reduction* was coined in Massachusetts during informal discussions among environmental advocates who were searching for a new policy approach to reducing the release of toxic chemicals. At the time, the Massachusetts Department of Environment Protection (MassDEP) estimated that Massachusetts firms generated 500 million pounds of toxic wastes each year. More than a thousand hazardous waste sites had been identified in the state, and more than fifty communities had lost part of their drinking water supplies to toxic chemical contamination.

Meanwhile, the costs of managing and disposing of hazardous wastes and the specter of future liability from mismanaged wastes were becoming an increasingly heavy burden for industry.

In 1989, Massachusetts became the first state in the country to pass a law that required companies to develop plans for reducing pollutants.

The concept of toxics use reduction was introduced in bills in both the 1987 and 1988 state legislative sessions. In 1989 members of the Massachusetts business community and representatives of the environmental and public health communities sat down to negotiate a bill that would be acceptable to all parties. After four and a half months of intensive negotiations, consensus was reached on a bill that was passed unanimously by both chambers of the Massachusetts legislature. The Governor signed the bill into law on July 24, 1989.

Today, TURA has become a model for pollution prevention legislation nation-wide and globally. Unlike most environmental legislation that typically mandates control technology and prescribes pollution “limits,” TURA facilitates reductions in toxics by providing mechanisms for companies to establish their own programs and their own reduction goals.

Voluntary Prevention Programs – Throughout the 1990s, the EPA sought to encourage pollution prevention through various voluntary initiatives. One of the first voluntary programs was the 33/50 Program, an ambitious program that encouraged the nation’s largest polluters to cut their releases to 33% and then to 50% from 1988 levels by 1992 and 1995, respectively. The program was so successful it spurred other voluntary and public-private partnership approaches such as:

- Design for the Environment
- Energy Star
- National Environmental Performance Track
- National Partnership for Environmental Priorities

Companies embraced the voluntary initiatives because they enjoyed the incentives – such as regulatory flexibility in achieving limits, and in some cases, public recognition – and they preferred the non-confrontational relationship with the EPA and other regulatory agencies. Meanwhile, parallel developments were taking place internationally. Several European countries established public-private programs focused on the development and adoption of “clean technologies” that use less or no toxic chemicals. The United Nations has established the International Cleaner Production Information Clearinghouse to disseminate the concepts of pollution prevention and clean technologies around the world.

Perhaps the most well known voluntary initiative from the 1990s was the International Organization for Standardization (ISO) 14001 standard, adopted in 1996 and updated in 2004. Companies can become ISO certified by developing, implementing and maintaining an Environmental Management System (EMS), a mechanism for tracking, assessing, and continually improving environmental performance. An EMS under ISO 14001 is just one type of environmental management system that companies can develop.

When implemented properly, the TUR planning process not only results in a reduction in the use of toxics, it can also enhance productivity and conserve all types of resources.

Increasing evidence shows that some toxics can be dangerous to humans and the environment even in small quantities.

Governments realized throughout the 1990s that, while the threat of regulatory enforcement was still necessary to protect the environment, it could be successfully augmented through effective voluntary initiatives.

1.3.4 2000s – Emphasis on Management Systems and Higher Hazard Substances

The trend toward voluntary initiatives still continues today. The environmental management system model encourages companies to go beyond basic regulatory requirements and even beyond TUR as they strive toward environmental sustainability, and to track their performance improvement.

Other state and foreign environmental policies have also been on the rise. California's Proposition 65 has been a success in reducing the use toxic chemicals by requiring businesses to disclose information to the public if there are toxics in the product or service that the business is providing. European's Registration, Evaluation, Authorisation and Restriction of Chemicals (REACH) is like no other environmental policy in the US, because REACH requires industry to register and evaluate their new chemical for a product or service before its use. In addition to REACH, Europe has the Restriction of Hazardous Substances Directive (RoHS), which deals with so-called e-waste, or discarded electronic and electrical products.

As a result of these trends, US companies should be aware of these regulations, because today it's a global economy, and the TURplanning process can help.

The TUR framework provides a useful and logical foundation for companies to develop an environmental management system (EMS).

1.4 The Six TUR Techniques

How does a company reduce the use of toxics? There are six techniques for achieving toxics use reduction:

1. **Input substitution:** replacing a toxic substance or raw material used in a production unit with a non-toxic or less toxic substance. Examples include:
 - Soy-based inks instead of oil-based inks in printing
 - Aqueous cleaners instead of solvents
2. **Product reformulation:** reformulating or redesigning end products to be nontoxic or less toxic upon use, release, or disposal. Examples include:
 - Making latex paint instead of oil paint
 - Making unbleached paper instead of bleached paper
3. **Production unit redesign or modification:** using production units of a different design than those used previously. Examples include:

1. Input Substitution

- Replacing a toxic or hazardous substance or raw material used in a production unit with a non-toxic or less toxic substance.

Examples:

- Substitute soy-based inks for petroleum-based inks
- Substitute vegetable-based fluids for oil-based cutting fluids
- Substitute water-based pigments for toxic ones

2. Product Reformulation

- Reformulating or redesigning end products to be nontoxic or less toxic upon use, release or disposal

Examples:

- Decrease the amount of solvent needed to manufacture paint by switching to a high-solids formulation
- Introduce new product lines specifically designed to eliminate the use of toxic chemicals

- Electrostatic paint spray instead of solvent-based paint
 - Ozonation instead of chlorine for corrosion control
4. **Production unit modernization:** upgrading or replacing production unit equipment or methods. Examples include:
- Continuous closed system instead of batch process
 - Counter-current rinsing instead of single rinse tank
5. **Improved operation and maintenance:** modifying existing equipment or methods by such steps as improved housekeeping, system adjustments, or process/product inspections. Examples include:
- Computerized inventory control, spill prevention program
 - Floating covers on heated baths to prevent evaporation
6. **Integral recycling:** using equipment or methods that are **integral** to the production unit. Examples include:
- Hard-piped recycling system
 - Closed-loop, refrigerated condensation of vapors

1.5 TUR and Planning

TUR planning is a process that involves a team of employees representing various departments within a company, each with different responsibilities and/or areas of expertise. The planning process involves:

- Examining how toxic chemicals are manufactured, processed, or otherwise used, and how byproducts are generated.
- Identifying TUR techniques.
- Evaluating the technical and economic feasibility of potential TUR techniques.

The TUR planning process is designed to complement a facility's existing planning processes as much as possible. TURA does not specify *how* to plan, leaving companies free to develop whatever planning process and format works for them.

1.5.1 Continuous Improvement in TUR Planning

There are four basic steps in a continual improvement process: plan, implement, evaluate, and review. The TUR planning process is not intended to be static. The review and update process is meant to facilitate further reductions in toxics use and byproduct generation through **continual improvement**. In this way, the cycle may be more appropriately viewed as an upward spiral, rather than a flat circle.

3. Production Unit Redesign or Modification

- Developing and using production units of a different design than those currently used.

Examples:

- Upgrade tool and equipment quality to reduce off-spec products.
- Install automatic thermostats or automatic flow controls.
- Install high-performance nozzles, brushes, and applicators to conserve coatings and reduce the number of re-ject products.

4. Production Unit Modernization

- Upgrading or replacing existing production unit equipment and methods with equipment and methods of a more recent design.

Examples:

- Install counter-current rinsing systems to reclaim process chemicals.
- Use air knives to blow solutions back into baths.
- Replace solvent-based paint strippers with mechanical processes.

5. Improved Operations and Maintenance

- Improved housekeeping, system adjustments, product/process inspections, or production unit control equipment or methods.

Examples:

- Institute employee training programs.
- Install splash guards and dip boards.
- Implement inventory control program to prevent expiration of chemicals.

6. Recycling (Integral to the Process)

- Recycling, reuse, or extended use of toxics by using equipment or methods which are integral to the production unit, including, but not limited to filtration and other closed loop methods.

Examples:

- Capture and recycle cleaning solvents.
- Regeneration of acid instead of disposal of acid.
- Recycle and reuse spent rinse water.
- Distill and reuse solvent strippers.

Incentives for TUR

- Identifies potential cost savings.
- Provides a systematic materials tracking program.
- TUR planning methods can provide a foundation for future EMS or ISO programs.
- Identifies process or chemical inefficiencies.

1.5.2 How can continual improvement be built into the planning process?

Continual improvement can be built into the planning process by:

- *Building and maintaining a strong TUR planning team.* The planning team should become a standing part of the ongoing management of the facility.
- *Scheduling periodic reviews.* A schedule should be established in the plan for periodic reviews and reports.
- *Building in methods to evaluate and reevaluate performance.* The performance of the TUR projects should be periodically assessed against the expected technical and financial returns. The results of these evaluations should not be couched in terms of successes or failures but, rather, in terms of lessons learned and future opportunities.



2 Process Characterization: Process Mapping

Objectives: After this module participants will be able to:

- Develop a visual representation of a production process
- Assess a production process and determine the best way to divide it up into production units
- Conduct a chemical pathway analysis of a process
- Distinguish between products, processes, and production units



2.1 Introduction to Process Characterization

The heart of the planning process is the process characterization.

There are three steps to completing a process characterization: Process Mapping, Production Unit Information, and Materials Accounting. Process characterization is the basis for the rest of the TUR planning process, so it is crucial to be thorough in this area. If the processes are not carefully characterized from the outset, the planning process will be very difficult. The data developed in this stage will help determine the toxics used and the byproducts generated, thereby enabling the company to identify TUR opportunities.

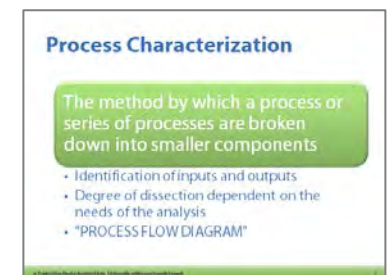
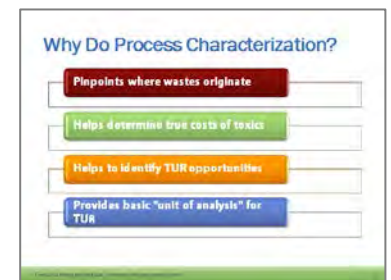

2.2 Process Mapping

A process flow diagram is a visual representation of the movement of the toxic chemical through the processes within a facility. Process flow diagrams can vary considerably in their format and the level of detail they provide.

At a minimum, a process flow diagram must represent all the steps through which material inputs pass to form a product, and the point at which toxics enter the system and leave the production unit (for example, as product, byproduct, emissions, or releases, such as fugitive emissions). It can also include waste treatment activities and non-integral recycling. Process flow diagrams may also include information such as energy inputs, non-toxic material flow and labor inputs.

For most manufacturing processes, the simple process flow diagram may not be acceptable or useful because it is too general. It may not provide enough information about specific byproduct and emission releases. Also, the process flow diagram used in TUR planning should pay special attention to several steps often neglected in traditional process flow diagrams, such as:

- Materials storage and handling
- Equipment maintenance and repair
- Byproducts released to the environment as fugitive emissions, spills and leaks

Process Flow Diagrams help foster a shared understanding of production processes that is comprehensive and intuitive. Most people find a graphical representation of production to be easier to understand. Thus, Process Flow Diagrams help facilitate discussion and decision making. TUR Process Flow Diagrams show immediately where toxic substances enter and leave the production process, create a basis for determining financial costs for toxics use, as well as forming the basis for planning improvements. Process Flow Diagrams are superior to other types of process documentation, such as checklists or outlines, because they readily indicate the sequence of operations and the relationships of process elements to one another.

Most production units are **linear** or **continuous**. Materials are introduced at one end, flow through the process, and emerge as finished products at the other end. Figure 2A presents a continuous-flow process flow diagram for one process in a pulp and paper production facility.

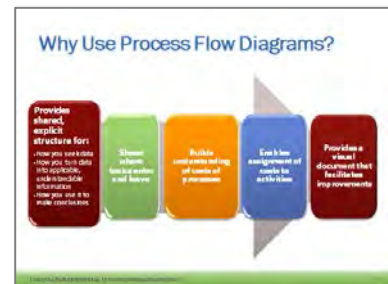
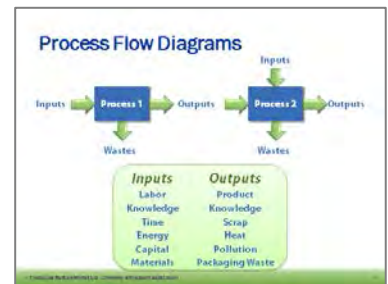
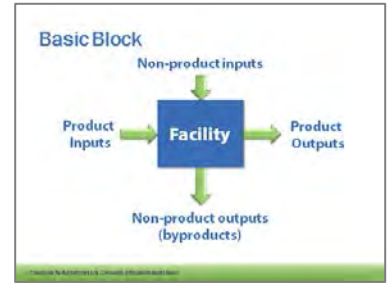
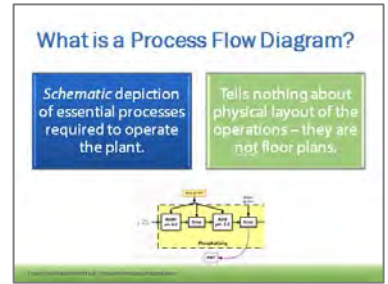
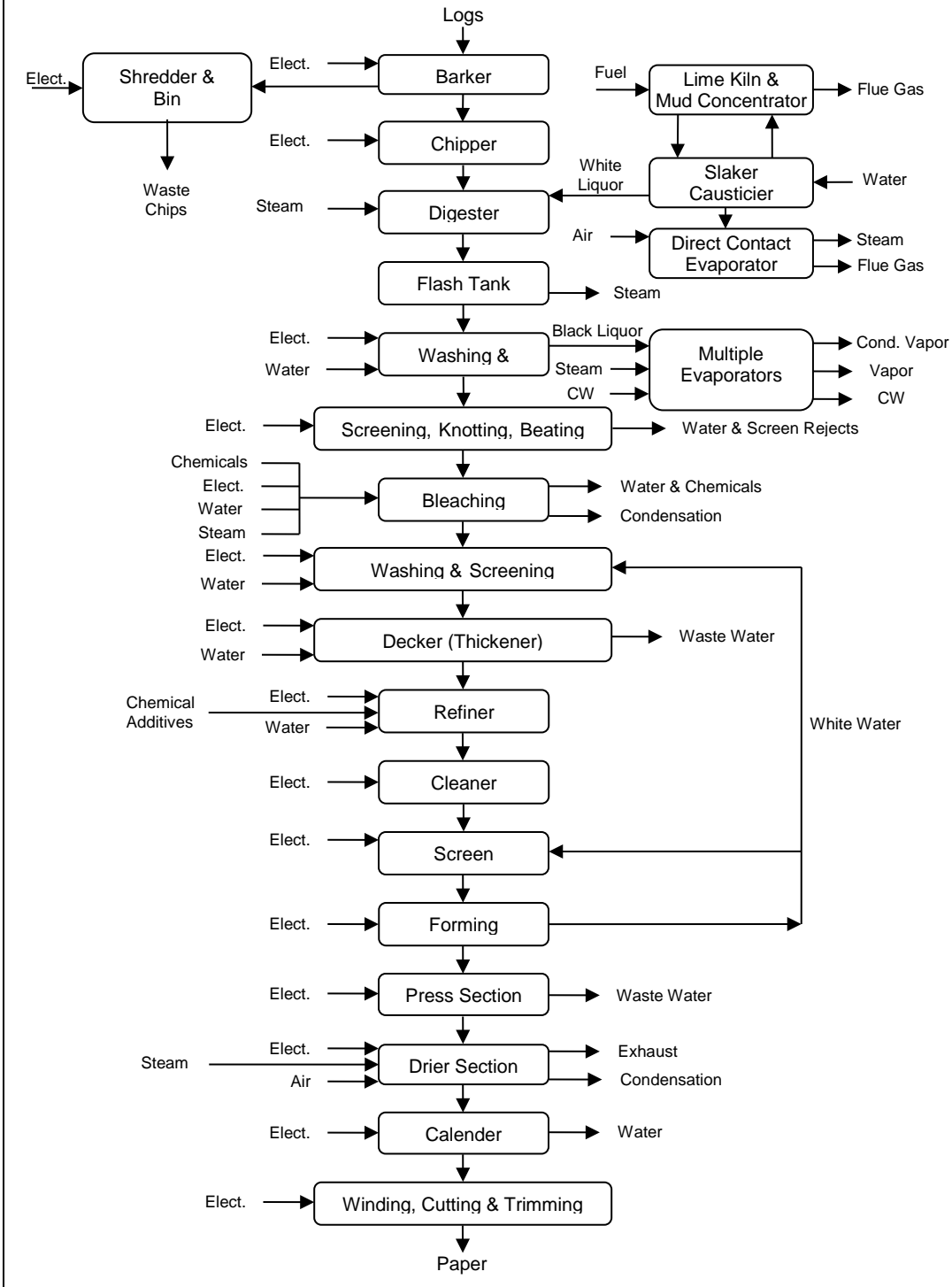
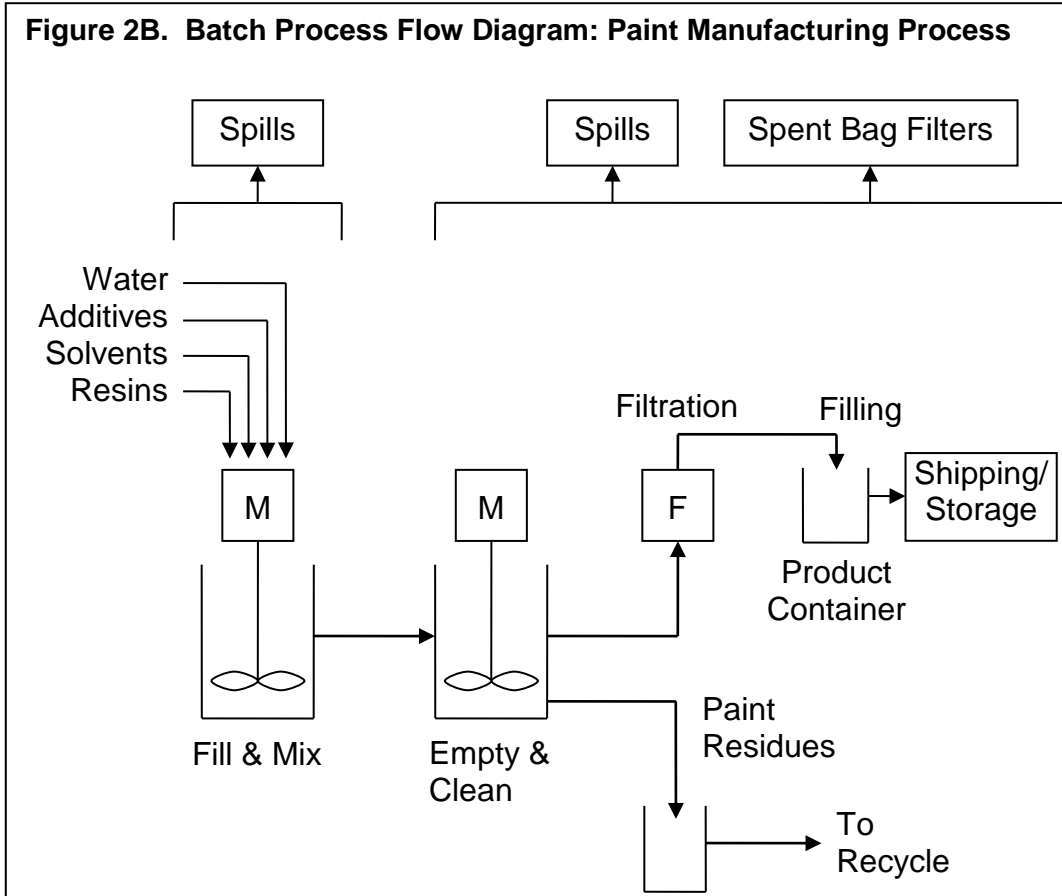

Figure 2A. Process Flow Diagram for a Pulp and Paper Production Facility (continuous flow)



Some productions, like paint making, occur in batch processes. Batch processing, where several operations are carried on in one container, require more careful attention in constructing a process flow diagram because the actual steps are not spatially separated. Figure 2B presents a process flow diagram for a simple paint manufacturing line.



2.3 Chemical Pathway Analysis

TURA requires that a process flow diagram represent the movement of each toxic through the production unit. This is often referred to as chemical pathway analysis, and it involves tracing the flow of each toxic material from the point of introduction into the production unit through to the point it is released from the production unit, either as a product, byproduct or emission.

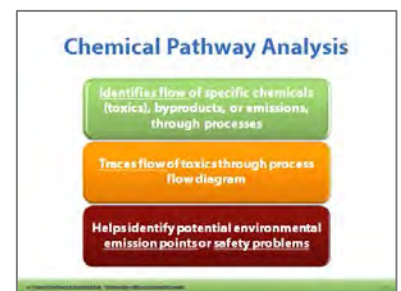

Pathway analysis is useful for identifying all of the potential points at which a toxic may be released to the environment, create safety problems, or expose employees. To chart out a chemical pathway, draw a line through the process flow diagram in a manner that traces the movement of the chemical through each step of the process. In more complex production units, the chemical pathway may have several branches as material inputs are divided up between various production lines. Figure 2C traces the chemical pathway of sodium hydroxide use in a facility.

A *chemical pathway analysis* traces the flow of a specific chemical through the production operations on a **process flow diagram**.

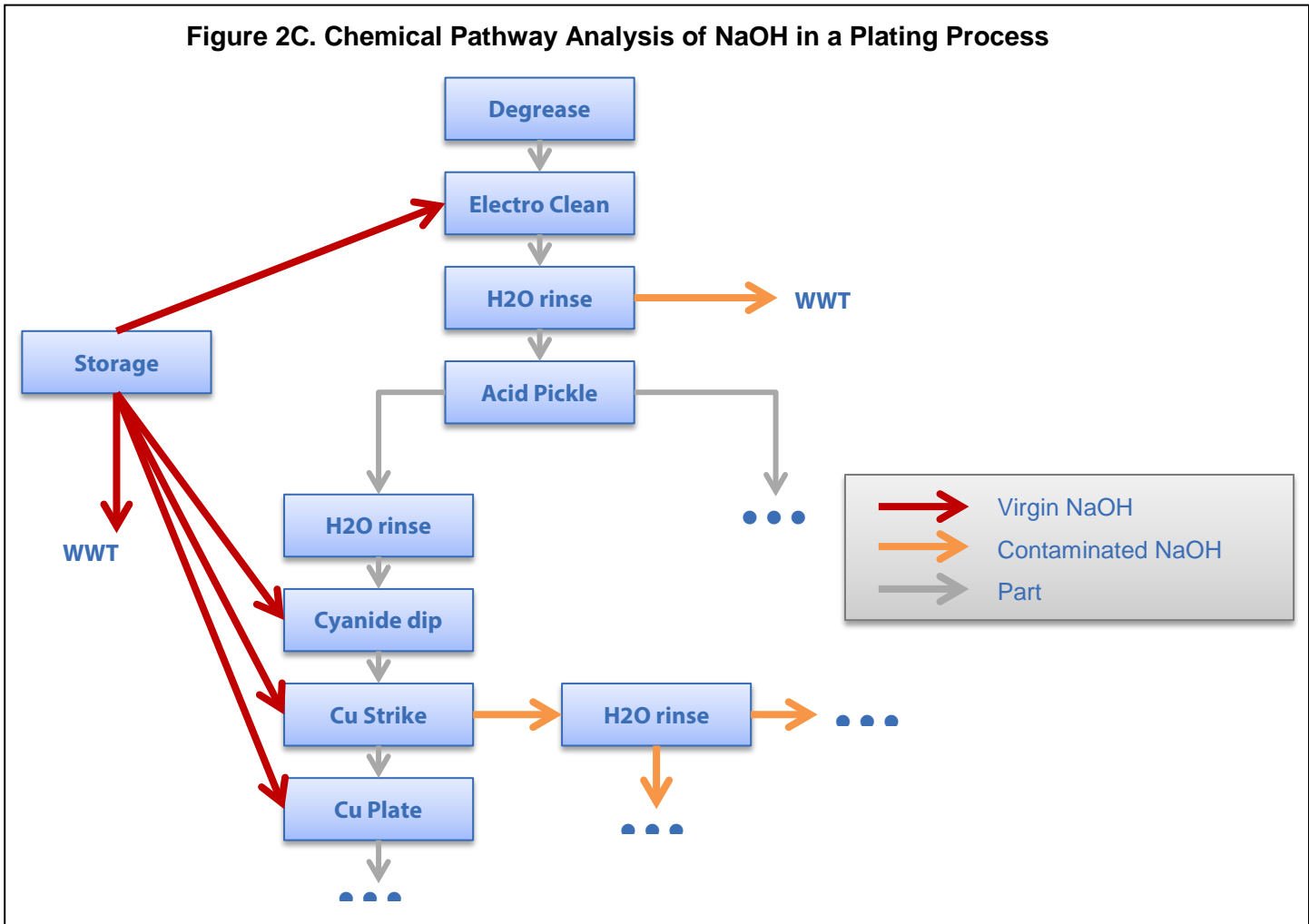

Sometimes toxic chemicals may be created during production, in which case the chemical pathway would begin at the point at which the chemical is manufactured. In other cases, a chemical may be converted into other non-targeted chemicals during production. The neutralization of acids during production operations provides a good example. In such cases the chemical pathway may end in a production unit. It is always useful to assume that some material was not totally consumed in the conversion and to trace the route of the residuals as they enter the product or leave the production unit as an emission.

2.4 Defining the Product

The most fundamental unit of process characterization is the *product*. A product is the outcome of a production process. The easiest way to think of products is to list the items conventionally identified as such in the accounting, inventory, or manufacturing processes. Some products, such as fountain pens or dolls, are quite obvious. In other cases a product might be a service or a result, such as washed clothes or repaired measuring devices.

What is an intermediate product?

An *intermediate product* is any item that leaves one production process bound for another. These include products shipped off-site, transferred between on-site production processes, or moved to storage as an intermediate step in the production of a final product. For instance, an object that has been primed and sent to storage before final painting could be identified as an intermediate product. In TURA reporting, intermediate products are simply considered as products.

What is a family of products?

In some cases product is defined in terms of families of either products, intermediate products, or results, where each use the same toxic chemicals, produce the same toxic chemicals in the waste stream, or are interchangeable; or, simply, where the firm considers all the results the same product.

A firm may identify a family of products as a product if it produces many different colors of paint or different sizes of switches (all products of the same processes using the same chemicals), or different types of cleaning (using the same chemicals). A firm may not consider as a family of products a group of transformers made on the same production line but containing different toxic constituents.

What is a result?

Some toxic chemical users do not produce products in the conventional sense. An industrial uniform dry cleaner produces a service or *result*: a cleaned uniform. A firm may annually clean its pipes with a toxic chemical. The cleaned pipe is a result of the cleaning process. Such results can in certain instances be considered a product.

2.5 Defining the Unit of Product

When measuring toxics use reduction, the selected measure must be normalized against the level of production in order to guarantee that changes in chemical use reflect true toxics use reduction and not simply reductions due to decreases in the level of production. Therefore the

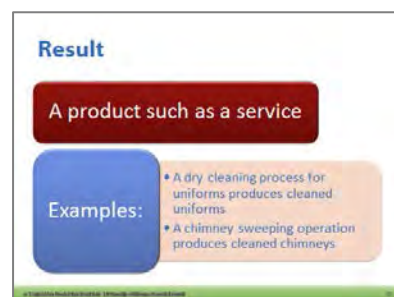
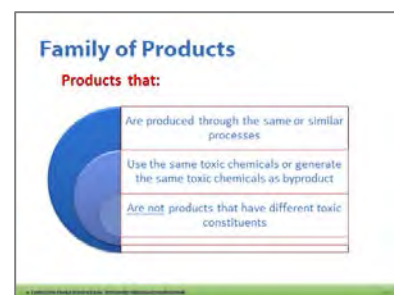
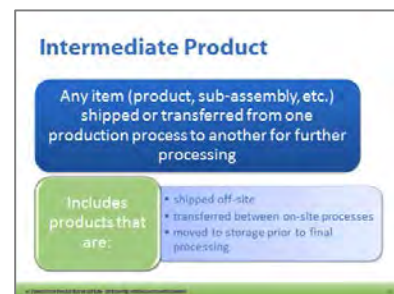

output of a production unit needs to be represented by some metric that accurately reflects the level of production.

TURA requires that firms identify an appropriate *unit of product* in order to standardize these measures. A unit of product is some measure of product output that is directly related to the level of production.

The law leaves firms free to define their own unit of product. Careful attention should be given to defining an appropriate unit of product, because future efforts to report success in toxics use reduction will be affected by the unit of analysis you have selected. In selecting a unit of product, try to pick a measure of facility productivity that closely reflects all activities involving the listed toxic chemicals.

Defining an appropriate unit of product is not always obvious. For instance, a plastic bag manufacturer may want to define the “number of plastic bags” as the unit of product. But if this manufacturer produces a variety of plastic bags ranging from thin ones made up of one layer of plastic film to others made up of many layers of plastic film, the firm may wish to define “pounds of plastic film” as the appropriate unit of product. A unit of product should be some kind of physical measure. A non-physical measure can be used as a unit of product, but care must be taken in normalizing all measures. For example, dollar sales as a unit of product should be corrected for the influence of inflation.

Good examples of units of product are:

- Gallons of paint manufactured
- Square centimeters of jewelry plated
- Pounds of nails manufactured

In choosing a unit of product, the operative question should be: Is the magnitude of chemical use and byproduct generation per unit of product relatively constant for all products and production levels within the production unit? If the answer is yes, then the unit of product will serve as a reliable standard for measuring TUR progress. It will provide a measure that is unaffected by shifts in the rates at which various products are made.

Unit of Product

A measure that reflects the *level of production* associated with use of toxic OR generation of toxic as a byproduct

Toxics use reduction should be normalized against the level of production to track progress

Select a measure of facility productivity that closely reflects activities involving toxics



ILLUSTRATION: UNIT OF PRODUCT

The Difficulty of Defining a Unit of Product

Semiconductor manufacturing offers complexities in determining the unit of product since most processing involves silicon wafers, not individual chips. Although there are numerous chips on a single wafer, not all the chips end up being functional. The quantity of substances used in semiconductor manufacturing relates more to the number of silicon wafers processed than to the number of chips produced. Thus, a decision can be made to use “silicon wafers processed” as a unit of product instead of “semiconductor chips produced.”

Unfortunately, the complexity is not resolved by using “silicon wafers processed” as the unit of product since there is variability in:

- wafer size—4-, 2-, 6-inch and
- masking layers—10, 13, 20

Depending on the processing technology employed, the wafer size and number of masking layers changes. Also, the number of masking layers increases the amount of toxic chemicals used.

A Creative Solution

The wafer size problem can be corrected by using “square inches of silicon processed” instead of number of wafers processed. The masking layer variable can be accounted for by using a **complexity factor**.

The **complexity factor** is directly related to the number of masking layers. As the technology becomes more advanced, more components can be put on a single chip. This requires more layers on a wafer and, in turn, more chemical usage per wafer. The complexity factor is multiplied by square inches of silicon to give a unit of product that relates more to the actual chemical usage.

Example:

10 layers ————— factor = 1.0

12 layers ————— factor = 1.2

(Adapted from a paper by Rose Sweeney, Dow Chemical)

1.6 Using Existing Process Maps

Many plants, particularly larger production facilities, have on-site process flow diagrams. These may be fairly comprehensive diagrams that were completed at the time the facility was built or they may be diagrams specific to a particular piece of equipment or production unit. Such diagrams may exist as:

- Vendor-supplied operating manuals
- Process engineer’s layout diagrams
- Architect’s facility plans
- Piping and instrument diagrams
- Critical path management diagrams, or work flow diagrams

Such “found” process flow diagrams can be of great benefit in characterizing production units. At the same time, these diagrams should never be trusted to reveal everything necessary to conduct effective TUR planning. Too often the diagrams are outdated by shop floor adaptations that have altered and improved the equipment or routines. Always validate

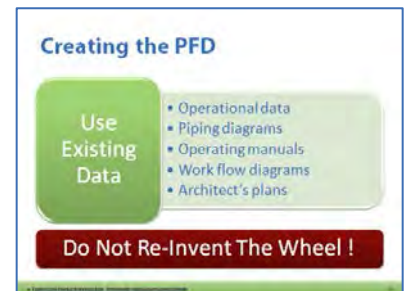

the “found” diagrams with an on-site review of the equipment or procedures.

2.7 Conducting a Walk-Around

A walk-around review is a process by which the planning team gains visual familiarity with the plant and the production units of interest. A comprehensive walk around can provide several benefits to a planning team. These include opportunities:

- To bring all team members equally up-to-date on the plant operations
- To document and verify the process flow diagrams
- To identify other plant personnel who might have specific knowledge or options ideas
- To identify potential options for toxics reduction

Carrying around copies of the relevant process flow diagrams may be useful during the walk-around in order to effectively associate the diagrams with the equipment and to verify the diagrams with the actual operations. It may be useful to schedule several walk-throughs to account for shift or seasonal variations in production and to review cleaning, maintenance, or repair procedures as well as direct production operations.

Schedule the initial walk-around when all or most all of the production units are in operation. Carefully check the diagrams against the layout and functioning of the equipment. Take notes on problem areas that appear as well as ideas that occur to you on options to reduce the use of toxic chemicals.

Talk to those with shop floor experience. Employees often have ideas or information that can be highly useful in properly characterizing production units or identifying options to reduce risk.

It may be useful to include some employees or shop stewards as you conduct the tour. Ask employees about maintenance and repair procedures and schedules. Seek information about length of time materials are in stockrooms or storage areas. Carefully chart how materials and products are transported about the facility.

At the conclusion of the walk-around, have someone write up the findings of the tour. Note the areas where questions arose so as to identify further information needs. Also note the spontaneous ideas that arose about how to reduce the use of toxic chemicals or how to improve the efficiencies of material or energy use.

In larger facilities conducting a couple of walk-arounds at different times may be useful to assure a solid understanding of the production processes.

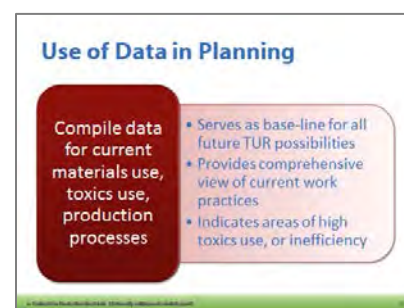
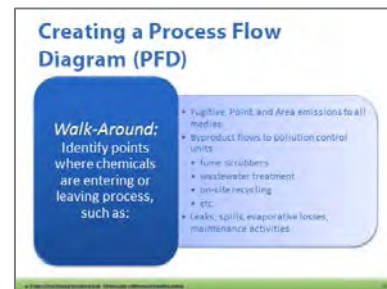

3 Process Characterization: Materials Accounting

Objectives: At the end of this chapter participants will be able to:

- Determine how to assess materials use in a production unit
- Differentiate between a byproduct and an emission
- Demonstrate mass balance and materials accounting techniques
- Describe how to do an inventory of toxic chemical use and account for all of the toxic chemicals used

3.1 Introduction to Materials Accounting

The quantitative aspect of process characterization is known as materials accounting.

Materials accounting quantifies the total inputs and outputs of a given toxic chemical in the production unit and, ultimately, facility-wide usage. Input data generally describes the quantity of chemical used in the production unit. Output data describes the amount of a toxic chemical that leaves as product, is lost as byproduct, is treated on-site, and is released or transferred off-site..



3.2 Understanding Materials Accounting

Materials accounting helps you understand where and how substances are used, where opportunities exist for reductions in use and how to quantify the costs of using toxic chemicals. Using materials accounting techniques, you can determine how much of each toxic chemical was used, where it was used, and its fate – whether it was shipped in or as product, if it was destroyed (or created) in the process or if it became byproduct.

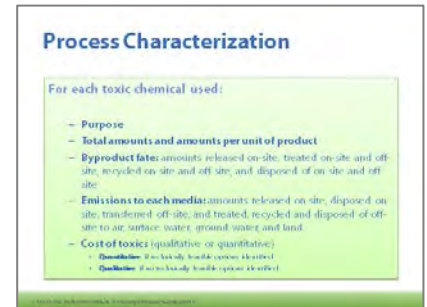

Materials Accounting vs. Mass Balance

The terms materials accounting and mass balance are sometimes used interchangeably. They are related, but they have slightly different meanings.

Materials accounting simply means tracking carefully the amount and location of material entering or leaving a system, such as a production unit or the facility as a whole.

A *mass balance* is a mathematical technique frequently used to achieve materials accounting. It is based on the principle that, in a closed system, “in” must equal “out;” it often involves solving several simultaneous equations to find an unknown quantity. An example of a mass balance calculation is provided in this module.

3.3 Understanding Byproduct and Emissions

Three things can happen to a reportable chemical after it enters a production unit:

1. It can become a product or part of one.
2. It can be consumed or transformed in the process.
3. It can become a byproduct.

A byproduct is any non-product output *before* handling, transfer, treatment or release. Generally, byproduct can be thought of as waste from the process.

An emission is a release to the environment or a transfer to an off-site location of a toxic substance. In other words, an emission is a byproduct that crosses the facility boundary. Figure 3A is a process flow diagram of a plating operation that illustrates this concept. Byproducts A1, S1, S2, and W2 become emissions when they cross the facility boundary.

While all emissions are byproducts before they cross the facility boundary, not all byproducts become emissions. For example, in Figure 3A, the byproduct in W1 is not necessarily equal to the total byproduct in W2 and S2. Byproduct can be created or destroyed in a treatment process. The following three examples represent possible scenarios for a process involving wastewater treatment such as in Figure 3A.

Scenario #1: The wastewater treatment for this plating operation is a dewatering process. In this case, byproduct is neither created nor destroyed. Therefore, the byproduct in W1 is equal to the byproduct in W2 and S2.

Scenario #2: In this scenario, the plating process involves a cyanide bath and W1 contains cyanide byproduct. The treatment process includes the addition of cyanide destruct water treatment chemicals. As a result of the destruction of cyanide byproduct, the byproduct in W2 and S2 is less than the byproduct in W1.

Scenario #3: The wastewater treatment process in this scenario results in the creation of nitrates and therefore the byproduct in W2 and S2 is greater than the byproduct in W1.

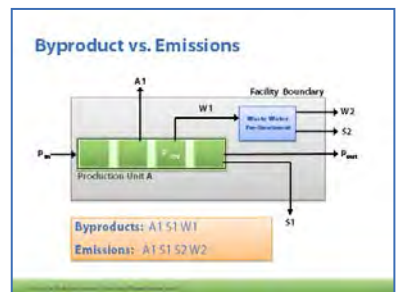
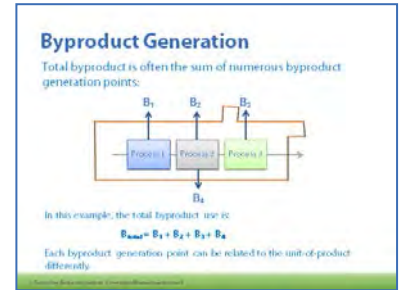

Figure 3A. Byproduct Example: Production Unit with Waste Water Treatment

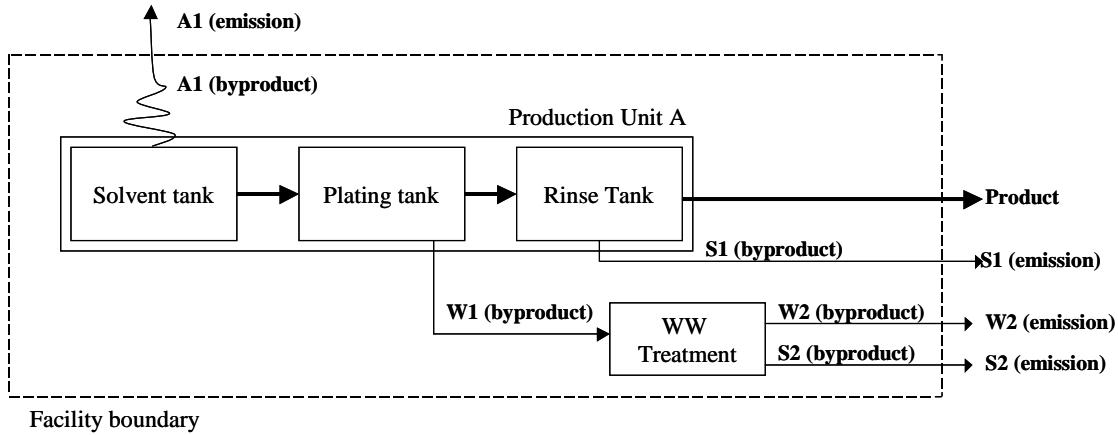

Figure 3B is a process flow diagram of a production unit with non-integral recycling, such as the simple distillation of solvent. During simple distillation, solvent wastes (R1) are heated, driving off the solvent in vapor form. The vapor is reverted back to liquid form in the condenser, collected and reused. The still bottoms, or waste remaining in the bottom of the still, are then collected and sent off-site for treatment or disposal (R2). R1 is greater than R2, so the total solvent byproduct generated is greater than the emissions of solvent. Simple distillation units are run in batches. Therefore, it is necessary to record the batch size and the number of batches per year in order to calculate the quantity of byproduct R1.

Figure 3B. Byproduct Example: Production Unit with Non Integral Recycling

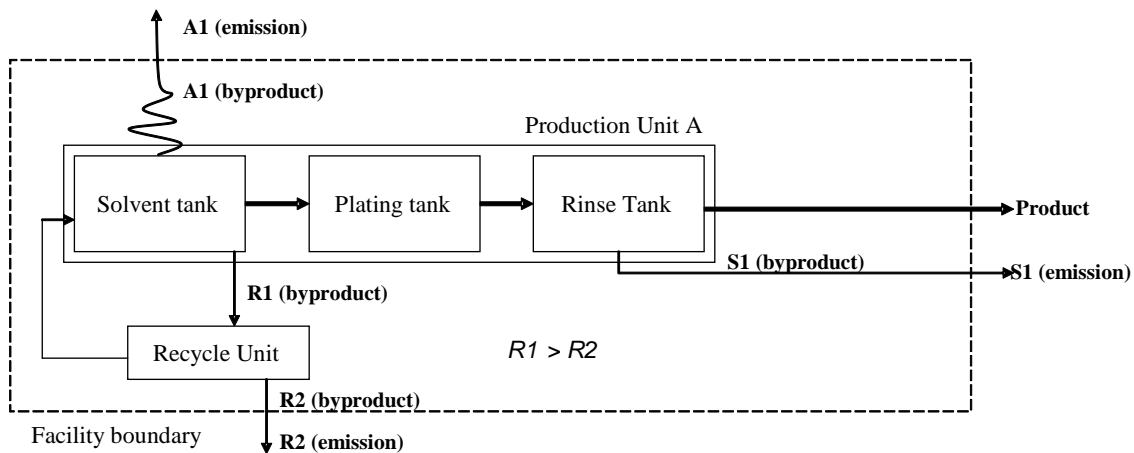
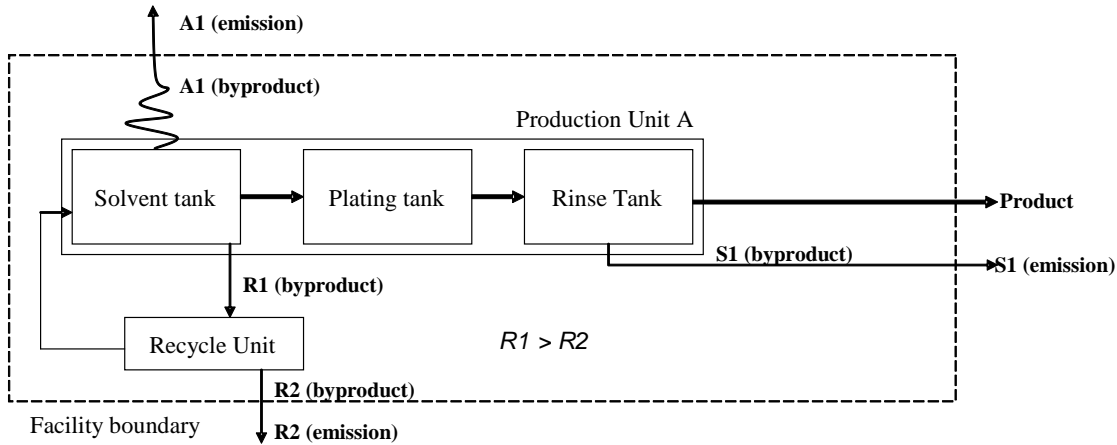

Figure 3C illustrates a production unit with integral recycling of solvent, such as with a hard-piped thin film evaporator. Thin film evaporators distill by running a thin film of dirty solvent down a heated cylindrical vessel where it is vaporized. The vapors are collected and condensed back into liquid form for reuse. Thin film evaporators are generally suited for use in high volume, continuous processes.

Figure 3C. Byproduct Example: Production Unit with Integral Recycling



In this integral recycling example, byproduct R1 is not counted because a hard-piped, continuous recycling process is used. The still bottoms (R2) are counted as byproduct and emission.

3.4 Materials Accounting Techniques

A mass balance is an accounting technique that equates the materials put into a process with the materials released by the same process. A mass balance is represented by the mass conservation principle:

$$\text{Materials In} = \text{Materials Out} + \text{Materials Accumulated}$$

3.4.1 Defining the System

To conduct a mass balance, a system must first be identified and encircled by an imaginary envelope. A “system” may range in size from a single tank in a plating line, to a production unit, or to the entire facility. Then all materials that pass into or out of the envelope are identified and accounted for over a specified period of time. At the close of the time period the materials that remain accumulated inside the envelope are measured.

No matter how large or small the envelope, the material “in” must equal the material “out” plus accumulated material inside the defined system. Any discrepancy between inputs and outputs plus accumulation indicates unaccounted material flows or errors in measurements.

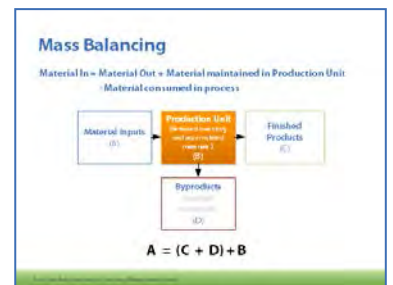
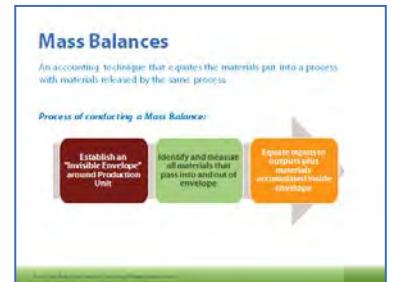

Example 3A illustrates the basic principles of a mass balance “envelope.” In this example, the envelope is first drawn around a production unit, then individually around the “process” and “recycling” steps of the production unit. In all three cases, the mass of material “in” equals the mass of material “out.” This **must always** be the case when accumulation is zero. It is important not to confuse the amount of material being recycled as being “accumulated;” nothing is being accumulated in this system since the amounts entering and leaving the envelope are equal.

When conducting a mass balance, it is important to define the mass balance envelope carefully. The envelope should be drawn around the process rather than a larger group of areas or a building that may contain functional elements unrelated to the process.

Example 3A. Mass Balance: Defining the System

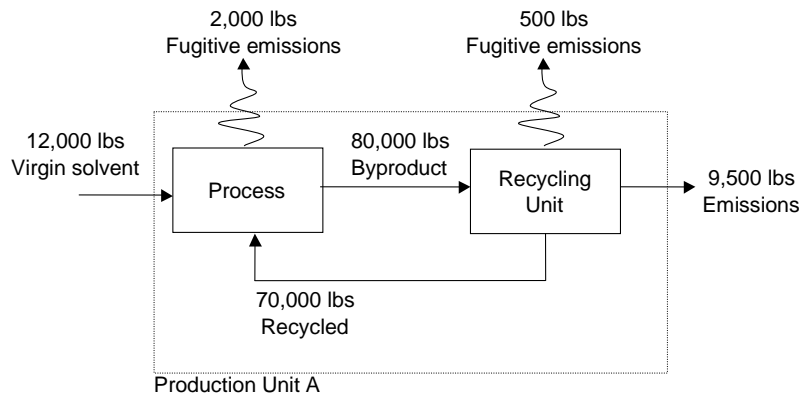

Production Unit Mass Balance:

$$\text{In} = \text{Out} + \text{Accum}$$

$$12,000 = 2,000 + 500 + 9,500 + 0$$

$$12,000 \text{ lb} = 12,000 \text{ lb} \quad \checkmark$$

Putting the envelope around smaller systems

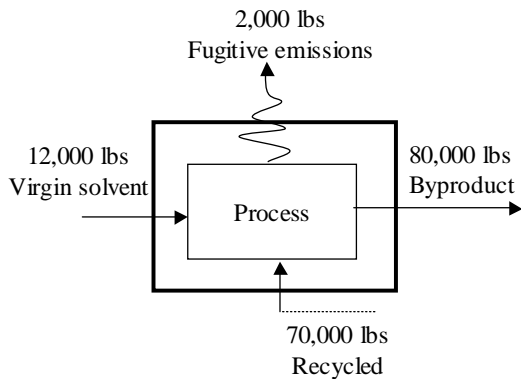

<i>Process Mass Balance</i>		
In = Out	+ Accum.	
12,000 + 70,000	= 2,000 + 80,000 + 0	
82,000 lb	= 82,000 lb	✓

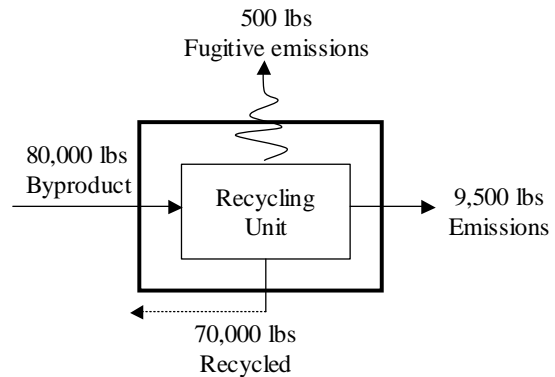

<i>Recycle Mass Balance:</i>		
In = Out	+ Accum.	
80,000	= 70,000 + 500 + 9500 + 0	
80,000	= 80,000 lb	✓

3.4.2 Accounting for Accumulation

A mass balance always requires identifying some discrete unit of time. If a process is routine and unchanging day by day, then one single day may be an appropriate unit of analysis. For many processes, there are changes due to contracts, production levels, or seasons. In such cases a fiscal year may be a better unit. The time unit selected should include the whole range of operations typically associated with the production unit.

Example 3B illustrates a system with an accumulation term.

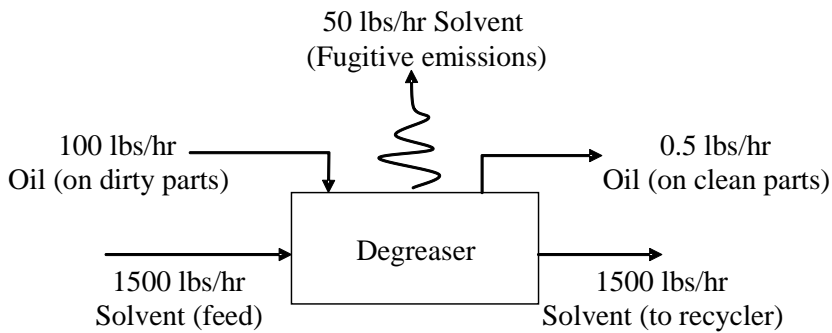
Example 3B: Accumulation Problem

Calculate the amount of oil accumulated and solvent lost in an 8-hour day

Oil Mass Balance:

$$\begin{aligned}
 \mathbf{In} &= \mathbf{Out} + \mathbf{Accum.} \\
 (100 \text{ lbs/hr})(8 \text{ hrs}) &= (0.5 \text{ lb/hr})(8 \text{ hr}) + \text{Accum.} \\
 800 \text{ lb} &= 4 \text{ lb} + \text{Accum.} \\
 \text{Accum} &= 796 \text{ lb.}
 \end{aligned}$$

Solvent Mass Balance:

$$\begin{aligned}
 \mathbf{In} &= \mathbf{Out} + \mathbf{Accum.} \\
 (1500 \text{ lbs/hr})(8 \text{ hrs}) &= (1500 \text{ lb/hr})(8 \text{ hr}) + (50 \text{ lb/hr})(8 \text{ hr}) + \text{Accum.} \\
 12,000 \text{ lb} &= 12,000 \text{ lb} + 400 \text{ lb} + \text{Accum.} \\
 \text{Accum.} &= -400 \text{ lb.}
 \end{aligned}$$

3.4.3 Solving Simultaneous Equations

It is often unusual to have complete knowledge of the actual amount of material entering or leaving a process or piece of equipment in a process. More commonly, you will have to calculate the mass of material based on data available, such as chemical concentration of a stream or the efficiency of a particular piece of equipment. For example, you may know from monitoring data that a certain wastewater stream has 700 ppm (parts per million) of a reportable chemical, or that a thermal oxidizer unit is 88% efficient at destroying Chemical A. From these data you must determine the total mass of chemical used in a given period of time.

In many cases, this type of problem involves solving a set of known equations to determine unknown values. The first and most important step is to draw the process flow diagram and label each stream (e.g., inputs, fugitive emissions, discharges, outputs, etc) individually. Second, break the system down into smaller units and set up a mass balance equation for each (i.e., draw the envelope around different entities of the system) to

determine all the known and unknown quantities. Third, solve the equations simultaneously – that is, substitute the known quantities into equations with unknown quantities. Finally, check your work to ensure that all the equations balance and that the quantities make sense. This technique is illustrated in Example 3C.

Example 3C. Solving Simultaneous Equations to Achieve Mass Balance

Fresh glycol ethers are fed into a photoresist application unit at a rate of 110 pounds per hour. Monitoring data show that 15% of the glycol ether stream evaporates as fugitive emissions. The remainder is sent through a filtration unit and then recycled back into the photoresist unit after being mixed with the fresh feed stream. However, the filtration unit is only 95% efficient and the unfiltered glycol ethers are sent to the POTW for treatment.

STEP 1: Draw a process flow diagram of this scenario and label it carefully. This is probably the most important step.

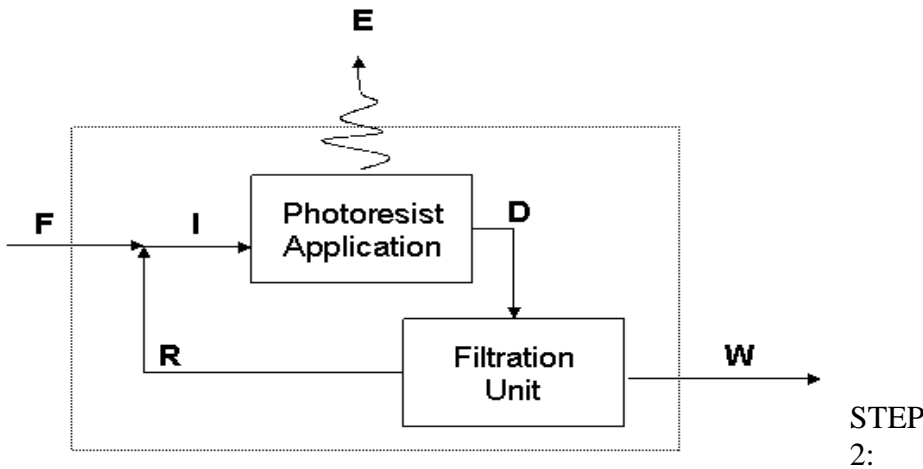

Determine equations and unknowns. (As long as there are as many or more equations than unknowns, the problem can be solved).

6 variables, 5 unknowns		6 equations	
Fresh feed	F = 110 lbs/hr	(1)	F = E + W
Input stream	I	(2)	I = E + D
Dirty stream	D	(3)	D = (0.850)(I)
Waste stream	W	(4)	W = (0.050)(D)
Emissions	E	(5)	E = (0.150)(I)
Recycle	R	(6)	R = (0.950)(D)

STEP 3: Substitute equations where necessary and solve until all variables are known.

Substitute Equation (3) into Eq. (4):

$$W = (0.050)(0.850)(I)$$

$$W = (0.0425)(I)$$

Substitute this result and Eq (5) into Eq (1)

$$F = (0.0425)(I) + (0.150)(I)$$

$$F = 110 \text{ lb/hr} = (0.1925)(I)$$

$$I = \mathbf{571 \text{ lb/hr}}$$

Solve other Equations for remaining variables

$$E = (0.150)(571 \text{ lb/hr}) = \mathbf{85.7 \text{ lb/hr}}$$

$$D = (0.850)(571 \text{ lb/hr}) = \mathbf{485 \text{ lb/hr}}$$

$$W = (0.050)(485 \text{ lb/hr}) = \mathbf{24.3 \text{ lb/hr}}$$

$$R = (0.950)(485 \text{ lb/hr}) = \mathbf{461 \text{ lb/hr}}$$

STEP 4: Check to ensure the solutions balance and make sense.

$$F = E + W$$

$$110 \text{ lb/hr} = 85.7 \text{ lb/hr} + 24.3 \text{ lb/hr} = 110 \text{ lb/hr} \quad \checkmark$$

$$I = F + R$$

$$571 \text{ lb/hr} = 110 \text{ lb/hr} + 461 \text{ lb/hr} = 571 \text{ lb/hr} \quad \checkmark$$

3.4.4 Materials Accounting with Mixtures

A very common type of calculation is determining the mass of a reportable chemical based on its composition in a mixture. For example, a Safety Data Sheet (SDS) indicates that a paint used in your facility contains 45% of a reportable chemical. This may either be a percentage by volume or by weight.* For example, 45% by volume means that in every 100 gallons of paint, there are 45 gallons of chemical. Likewise, if it were percent by weight, it would mean in every 100 pounds of paint there would be 45 pounds of chemical.

To calculate the amount (in pounds) of the chemical used it is important to know how the percentage is expressed because the overall densities of the paint and the chemical may vary, thereby providing different results. This is demonstrated in Example 3D.

* The technically correct term is “percentage by *mass*,” but “percentage by *weight*” is commonly used.

Example 3D. By-Volume vs. By-Weight Calculations

A screen printer used 4500 gallons of ink in a year. The MSDS indicates that the ink contains 55% methyl ethyl ketone (MEK). The specific gravity of the ink is given as 1.2. The specific gravity of MEK is 0.81. How much MEK is used if the percentage is by-volume? How much is used if it is by-weight?

SOLUTION: To convert a substance from gallons to pounds, the density of water, 8.34 lb/gal, is multiplied by the specific gravity – the density of the substance relative to water. The key to solving this problem is knowing which specific gravity value to use and when to use it.

By-Volume Calculation

For every hundred gallons of ink, there are 55 gallons of MEK, so in 4500 gallons of ink, there are 2475 gallons of MEK:

$$(4500 \text{ gal ink})(0.55 \text{ gal MEK/gal ink}) = 2480 \text{ gal MEK}$$

Now convert gallons to pounds:

$$(2480 \text{ gal MEK})(8.34 \text{ lb/gal})(0.81) = \mathbf{17,000 \text{ lb MEK}}$$

Density of water ↗
↖ *Specific gravity of MEK*

By-Weight Calculation

For every hundred pounds of ink, there are 55 pounds of MEK. First convert gallons of ink to pounds of ink:

$$(4500 \text{ gal ink})(8.34 \text{ lb/gal})(1.2) = 45,000 \text{ lb ink}$$

Density of water ↗
↖ *Specific gravity of ink*

Now determine the percentage of the ink that is MEK:

$$(45,000 \text{ lb ink})(0.55) = \mathbf{25,000 \text{ lb MEK}}$$

3.4.5 Materials Accounting with Concentrations

Another common materials accounting calculation is determining the amount of byproduct or emission based on monitoring data such as wastewater discharges, or airflow measurements. Concentration data are often presented in terms of parts per million (ppm). The key is converting a concentration such as ppm, which is unit-less, into pounds.

A stack monitoring problem is presented in Example 3E to illustrate this type of problem.

Example 3E. Stack Monitoring Data Problem

Calculate the amount of benzene (in lbs) that is emitted through a stack in a year, given the following data:

Volumetric flow rate = 34 ft³/hr

Concentration = 4500 ppm

M.W. = 78.1

Hours of Operation: 6000 hrs/year

STEP 1: Determine mass per volume

The molecular weight of benzene is 78.1. That means 78.1 gram/mol, which must be converted to mass per volume. At standard conditions, there is 1 mol/22.4 liters, so convert g/mol to g/L:

$$\frac{78.1 \text{ g benzene}}{1 \text{ mol benzene}} \times \frac{1 \text{ mol}}{22.4 \text{ L}} = 3.487 \text{ g/L}$$

STEP 2: Account for concentration

We are told the concentration is 4500 ppm – 4500 grams of benzene per million grams of air. Multiply this by the number you just calculated

$$\frac{4500 \text{ g}}{1,000,000 \text{ g}} = 0.0045$$

$$(0.0045)(3.487 \text{ g/L}) = 0.0157 \text{ g/L}$$

STEP 3: Convert to proper units

Convert g/L to lb/ft³ (there are 454 g in a pound, and 0.0353 cubic feet in a liter):

$$\frac{0.0157 \text{ g}}{\text{L}} \times \frac{1 \text{ lb}}{454 \text{ g}} \times \frac{1 \text{ L}}{0.0353 \text{ ft}^3} = 0.000980 \text{ lb/ft}^3$$

STEP 4: Calculate total based on flow rate and hours of operation

$$\frac{0.000980 \text{ lb}}{\text{ft}^3} \times \frac{34 \text{ ft}^3}{\text{hr}} \times \frac{6000 \text{ hr}}{\text{year}} = \mathbf{200 \text{ lb/year}}$$

3.5 Gathering Data

The objective of materials accounting is to present a complete and comprehensive picture of all of the materials used in a process or facility. Materials accounting is a means of obtaining chemical use data from readily available information. Data for materials accounting can be gathered in the following ways:

- Direct measurement (including metering and monitoring)

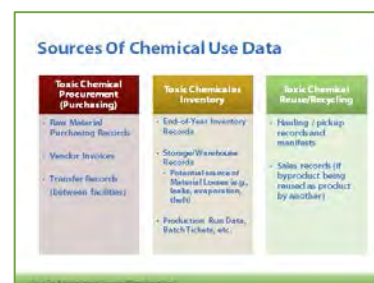

- Business record inventories
- Mass balance
- Byproduct and emissions accounting
- Engineering calculations

As illustrated in Figure 3F, information about materials in production facilities typically appears in seven categories:

1. Procurement (purchasing)
2. Inventory (storage and handling)
3. Material use (within operations)
4. Reuse
5. Byproducts
6. Emissions
7. Products

Figure 3F. Where to Gather Information About Chemical Use

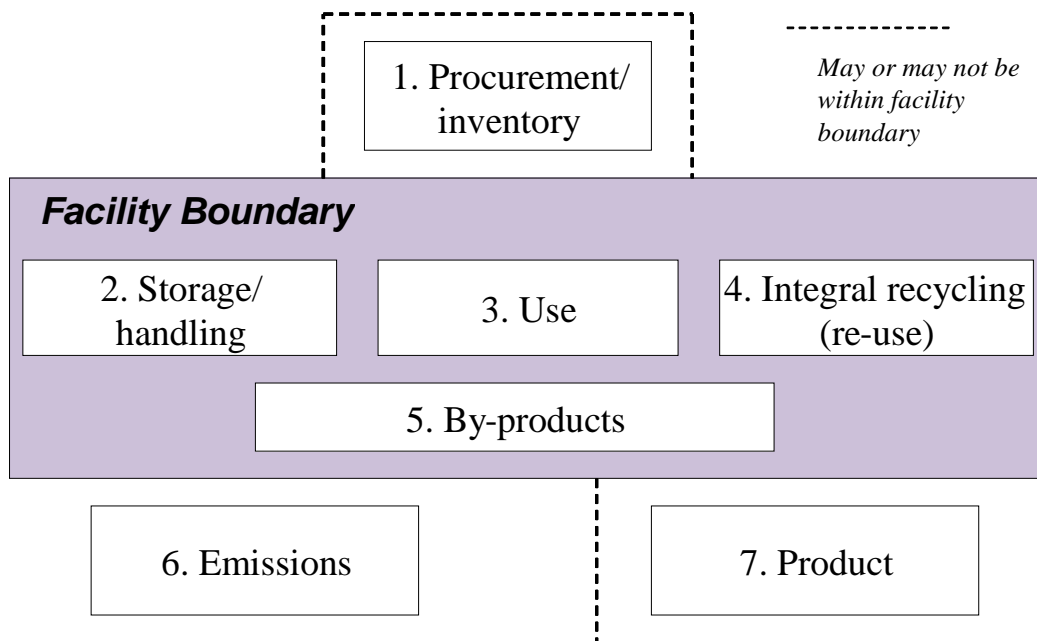

In many cases materials are easy to track because existing records clearly identify the chemicals. Difficulties occur when chemicals are created or transformed in a manufacturing process, or when exact quantities are undisclosed by the suppliers for proprietary reasons. Where requests for such information are rejected, materials accounting must rely on estimates.

3.5.1 Materials Procurement

Sources of information on materials procurement include:

- Raw material purchase records
- Transfer records (between facilities)
- Receiving dock records
- Vendor invoices

The best place to begin tracking materials is with the purchasing records for new material, usually located in a facility's business office. Purchasing records should be gathered for several recent years in order to identify seasonal trends and longer term market trends that will be useful in predicting future materials inputs.

In larger firms where materials are bought in bulk and distributed to facilities, transfer records typically serve the same function as purchasing records. Where materials are purchased in bulk and distributed to several production units, it may be necessary to develop a "distribution factor" and estimate the amount of materials sent to each production unit.

Purchased materials are occasionally returned before use due to errors in ordering, failure to meet specifications, or overstocking. Take care not to double-count materials. Make sure that all materials identified as purchased are actual inputs to the production units.

Finally, some materials may come into a facility as part of packaging or transport services and may not be identified on purchasing records. An example is formaldehyde used in packaging glues or used to fumigate transport vehicles.

3.5.2 Storage and Handling

Sources of information on materials as inventories include:

- End-of-year inventory records
- Storage records

Materials can often languish for years in storage areas. Materials can become lost, unneeded, or outdated. Materials may even disappear in storage due to leaks, evaporation, or theft. Poor inventory control can lead to inefficient materials distribution and problems in storage. It is, therefore, very important to account for materials that accumulate at facilities and do not become part of the product or byproduct outputs.

3.5.3 Materials Use

Sources of information on materials use include:

- Operations logs
- Samples, analyses, and flow measurements
- Batch make-up records
- Product specifications

- Internal transfer records
- Production line scheduling records
- Production line job sheets

Some materials move down a somewhat simplified chemical pathway from raw inputs directly to finished product constituents. Other materials take circuitous paths through a production unit, and still other materials may serve as intermediaries in the manufacture of the finished product.

Records are often not available, and materials use may vary dramatically depending on customer specifications or the variability of markets and seasons. In some cases estimates will have to be developed in order to assign specific quantities to materials use.

3.5.4 Integral Recycling (Reuse)

Integral recycling poses unique challenges in conducting a material balance because a facility-wide materials balance may not reveal the amount of materials reuse in practice. Accounting for materials recycling, such as reuse of solvents, plating baths, stripping and cleaning agents, etc., is vital in considering future options for expanding the reuse possibilities in a production unit.

Records on recycling and reuse are often difficult to find in a facility, as there may be little consistency over time in reuse practices, and reuse itself is difficult to monitor effectively. Give careful attention to accounting for materials reuse, because reuse can easily lead to double-counting materials.

3.5.5 Materials as Byproducts and Emissions

Remember that the only difference between byproducts (all non-product output) and emissions is that emissions cross the facility boundary (that is, they are released to the environment). Byproduct figures may differ from emissions figures if a chemical is non-integrally recycled. In that case, the amount of byproduct would equal the amount of emissions plus the amount non-integrally recycled.

Therefore, with the exception of non-integrally recycled material, byproduct and emission information can be found from environmental compliance records such as:

- Waste transport manifests
- Waste transporter invoices
- Invoices to scrap buyers and recyclers
- Sewer (POTW) discharge records
- Emissions inventories
- Toxics Release Inventory (TRI) forms
- Air source registration records

Some of these data are easily derived from manifest or discharge records. However, actual emissions may differ significantly from the permit records. Therefore, permit data should always be validated with other measurements or estimates.

The process of filling out a federal Toxics Release Inventory (TRI) Form R can reveal many emissions sources.

Materials lost as spills, leaks, and fugitive emissions need to be accounted for as well. The materials balance procedures recommended by the EPA for estimating fugitive emissions for reporting TRI data are useful here, but toxics use reduction planning requires data that is displayed at the level of a production unit. The aggregate losses can be computed by materials balance accounting, but this will not accurately distribute the losses to the points in the production unit where they actually occur.

A surprising amount of materials losses occur in storage and handling operations. Materials can volatilize or leak in storage, and handling materials increases the risks of spills and accidents. Carefully check the storerooms, loading docks, and transport passageways for revealing clues of materials leakage and spillage.

3.5.6 Materials as Products

Sources of information on materials in products include:

- Product shipment records
- Loading dock records
- Product specifications
- Invoices to customers (accounts receivable)

Some production materials leave the processes as constituents of finished products. In processes with high product-to-byproduct efficiency ratios, much of the materials input may leave the process in the form of a finished product.

Sales records provide a good starting place for establishing the amount of materials leaving as a part of the finished product. Sales records alone, however, will not be sufficient where products are composed of many materials or where the materials composition varies due to customer demand. A good example is a specialty paint that may be carefully formulated for a specific contract and never made thereafter. Where customer specifications require a certain amount of a material in a finished product, producers may add more than that required to assure that the product will never fall below specifications. In these cases, where products include many constituents, you will need to develop estimates to account for product outputs.



Summary of Data Sources

<p>Materials Procurement</p> <ul style="list-style-type: none"> \$ raw material purchasing records \$ transfer records (between facilities) \$ receiving dock records \$ vendor invoices <p>Materials as Storage and Handling</p> <ul style="list-style-type: none"> \$ end-of-year inventory records \$ storage records <p>Materials Use</p> <ul style="list-style-type: none"> \$ operations logs \$ samples, analyses, and flow measurements \$ batch make-up records \$ product specifications \$ internal transfer sheets \$ production line scheduling records \$ production line job sheets 	<p>Materials Reuse</p> <ul style="list-style-type: none"> \$ recycling records \$ reclaim records <p>Materials as By-Products</p> <ul style="list-style-type: none"> \$ waste transport manifests \$ waste transport invoices \$ invoices to scrap buyers and recyclers \$ sewer (POTW) discharge records \$ emissions inventories \$ Toxics Release Inventory Form R \$ air source registration records <p>Materials as Products</p> <ul style="list-style-type: none"> \$ product shipment records \$ loading dock records \$ product specifications \$ invoices to customers
---	--

3.6 Chemical Tracking

Collecting the previously mentioned data and organizing it into a database may enable the planner to more effectively inventory a facility. If a computer is used for tracking chemicals, its program must be set up to record inputs and outputs at the production unit level. Facility-wide aggregate data can also be determined, however. To plan for effective toxics use reduction, understanding the facility at the production unit level is essential.

Key Features of a Tracking Data Base

- Chemical inputs coded to production processes
- Chemical outputs coded to production processes
- Toxic chemical coded so that aggregate amounts can be determined
- Emissions and byproducts defined
- Regulations pertaining to each chemical included
- Considerations made for chemical reuse (avoid double-counting)

Accurately defining the inputs and outputs at the production unit level will allow the planning team to easily identify areas of opportunity for toxics use reduction. This process may also help in prioritizing areas or chemicals within the facility that require immediate attention.

Mass Balance in a Plating Operation Exercise

Below is a simple chrome plating production unit. The facility operates 8 hours a day, 7 days a week. Carefully review the process flow diagram and answer the following questions:

1. How much water is lost through evaporation from the plating tank each day? (Note: The chrome concentration in the plating solution is low enough to assume that water = solution drag-out).
2. How much wastewater is discharged per day from the rinse tank?
3. How much sulfuric acid is discharged in the wastewater each day? Should this specify that ounces are mass or volume?
4. If the rinse tank started clean on Day One, how much CrO_3 would remain in the tank at the end of Day Three if the average concentration over that time were 0.52 oz./gal.?

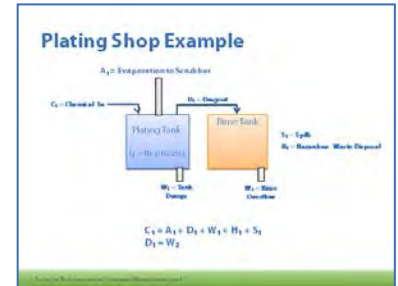

- #### Plating Shop Pollution Prevention Options
- Prevent drag-out (reduce D_1)
 - Use recovery technology* (return D_1 to process tank)
 - Base tank dumps on tank analysis (reduce W_1 & H_1)
 - Train operators to minimize spills (reduce S_1)
 - Cover tank when not in use (reduce A_1)
 - Implement preventative maintenance programs (reduce S_1)
 - * reverse osmosis, ion exchange or electrolytic recovery

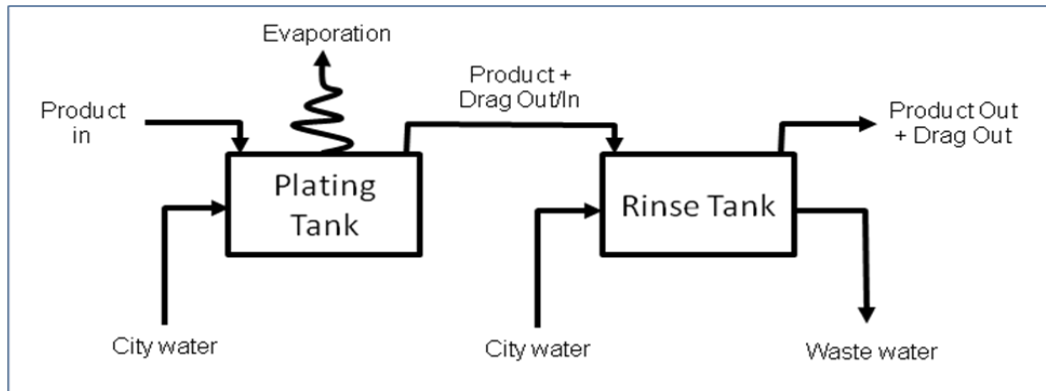

Plating Inputs		
Makeup water	180	gal/day
CrO_3	3800	ounces/day
H_2SO_4	?	ounces/day

Rinse Inputs		
City water	6.0	gal/min
Drag in	80	gal/day chrome solution

Plating Outputs		
Drag out	80	gal/day
CrO_3	1600	ounces/day
H_2SO_4	?	ounces/day
Plate out (on parts)		
Chrome	2200	ounces/day

Rinse Outputs		
Wastewater	?	gal/day
CrO_3	0.52	ounces per gal
H_2SO_4	0.0063	ounces per gal
Drag out	80	gal/day
CrO_3	0.52	ounces per gal
H_2SO_4	0.0063	ounces per gal

Metal Stamping Facility Exercise

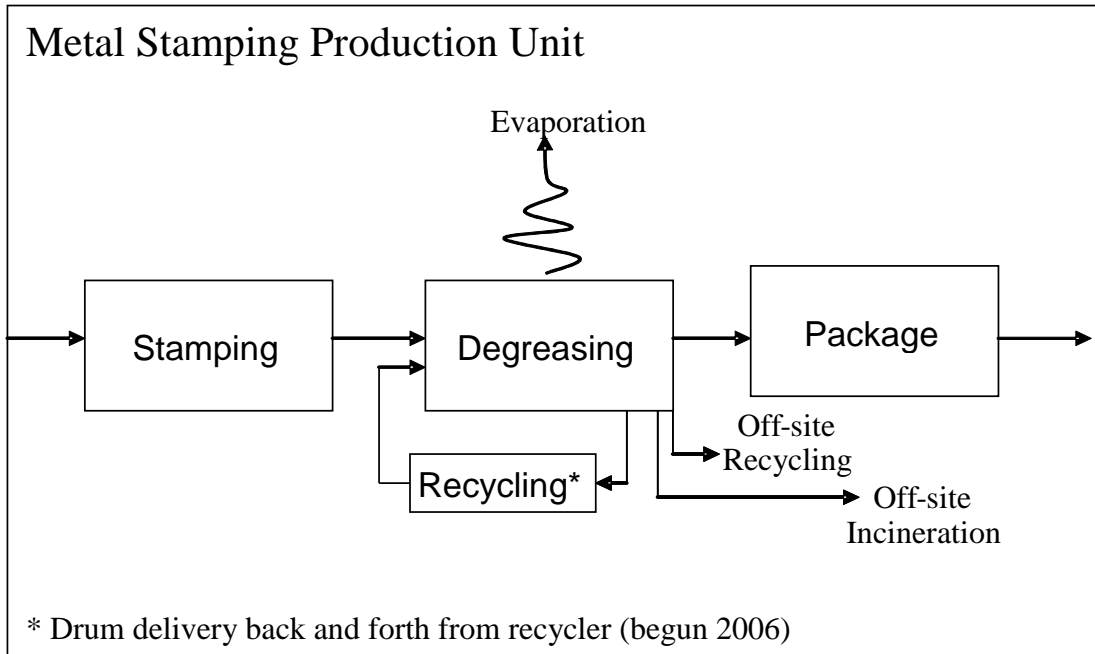

Use, Release, and Production Data			
	Solvent Quantities (lbs)		
	2004	2005	2006
Beginning Inventory	11,000	?	?
Amount Purchased	?	90,500	15,400
Ending Inventory	44,954	81,103	1,103
Recycled On-site	0	0	9,750
Recycled Off-site	39,854	?	42,904
Incinerated off-site	6,700	5,600	9,005
Fugitive Emissions	21,992	5,697	?

	Quantity of Parts Made (x000)		
	2004	2005	2006
Production	3574	2701	8413

1. Complete the Use, Release and Production Data table and calculate the solvent use for each year.
2. Calculate the solvent use per part produced.
3. Is the installation of on-site recycling TUR? Why?
4. Did this facility achieve toxics use reduction in 2006?

4 Identifying TUR Opportunities

Objectives: At the end of this chapter participants will be able to:

- Understand why it is important to generate a range of TUR options
- Learn tools and methods to help you generate TUR options

The next step in TUR planning after process characterization is to identify TUR options. This is the creative phase of TUR planning. The object of this phase is to generate as complete and thorough a list as possible of alternatives for reducing toxics and byproducts. Sometimes the TUR opportunities are obvious, for example, repairing a leak in a solvent tank, or upgrading outdated equipment with more efficient models. Other times the solutions are less clear. This is particularly true when different options will result in different costs and account for different benefits.

Working with a well-selected TUR Planning team can help in opening up the suite of options that you will be considering. Consider including members of existing health and safety or sustainability teams, as well as other key stakeholders on this time. It is important to think about who would provide valuable insights and creative ideas at this point in the TUR planning process. In order to assure that subsequent TUR planning activities build on what has been done in the past, be sure to plan agendas for your team meetings and record the key points from your discussions as you go along.

4.1 Identifying Options

Seeking a safer alternative that can serve the same function as a toxic chemical is not the only option to consider. In many circumstances it may not even be the best alternative. Using the ideas from your TUR team as well as other resources will lead to the most possibilities.

4.1.1 Brainstorming TUR Options

The search for TUR options is an open and creative process.

Brainstorming is a common and useful method to encourage people to think up creative ideas. The principle of brainstorming is to harness the collective creativity of a group to generate as many ideas as possible, with **no** regard (at this point) for their feasibility.

4.1.1.1 Helpful Guidelines for Brainstorming

While it is important not to stifle the creativity of the group with too many constraints, it is equally important to establish certain guidelines and

Introduction to Identifying TUR Options

The diagram shows two triangles. The left triangle is blue and labeled 'Identify' with the text 'Expand breadth of alternatives' above it. The right triangle is green and labeled 'Evaluate' with the text 'Cut alternatives to final choice' above it.

- Creative phase
- Generate complete list of TUR opportunities
 - Obvious opportunities
 - Hidden opportunities
- Costs / benefits

TUR Planning Team

- Who should be on the team
- When do you engage the various members of the team
- Create meeting agendas, including objectives of the meeting and anticipated next steps, to help ID who should be in the room

Information Sources for Options

- Safer alternatives technical resources
- Trade association technical support
- Industry trade journals
- Manufacturer/vendor information
- Experience of other companies
- State or other government technical assistance, information or research resources

Brainstorming TUR Options

Brainstorming

- Open / creative process
- Commonly used to generate ideas
- Encourages creative ideas
- Harnesses collective creativity
- Generates many ideas

criteria to guide the brainstorming. Below are some important guidelines that apply in almost every brainstorming situation:

1. No judgment, no evaluation - The focus of TUR brainstorming is to generate as many worthy and creative ideas as possible, NOT determining whether a concept is a valid or feasible TUR option.

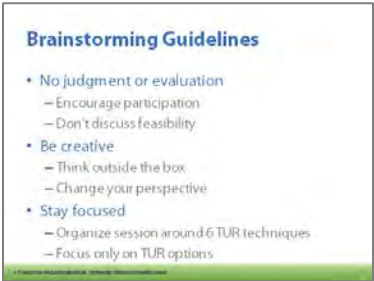

DO	<ul style="list-style-type: none"> • Encourage and allow each group member to participate • Treat every TUR idea as worthy
DON'T	<ul style="list-style-type: none"> • Discuss the feasibility of TUR ideas at this stage • Criticize

2. Be creative – Sometimes the most outrageous ideas can lead to the most effective solutions. Being creative in brainstorming does not necessarily mean inventing a new technology or formulation. It can be as simple as coming up with a different way to accomplish a task.

DO	<ul style="list-style-type: none"> • Think outside the box (let your imagination wander) • Change your perspective (imagine yourself in a role other than your own) • Hitchhike your ideas (let one idea generate another)
DON'T	<ul style="list-style-type: none"> • Feel bound by history (set aside convention and past experience) • Be inhibited (don't be afraid to speak up in the group)

3. Stay focused – While you don't want to limit your creativity with too many boundaries, it is important to ensure that the TUR brainstorming process does not stray from *reduction to control, treatment*, or other process changes that do not count as TUR.

DO	<ul style="list-style-type: none"> • Organize your brainstorming session around the 6 TUR techniques (consider in turn each of the six kinds of TUR options defined by TURA, so that you have 6 mini-brainstorm sessions for each production unit) • Present a memory-refreshing summary definition of each of the six TUR options
DON'T	<ul style="list-style-type: none"> • Brainstorm ideas that are not TUR

Brainstorming can produce a range of benefits. It can help in guaranteeing commitment from participants because they are part of the process. Further, brainstorming does not have to be done solely with toxics use reduction in mind; this activity can be used to improve efficiency in the use of all materials. Successful companies know that their most important asset is their people. It is when people are allowed, encouraged and motivated to find creative solutions that great ideas spring forth.

4.1.2 Information Sources for Alternatives

Just as finding less hazardous, high performing, cost competitive, drop-in substitutes for hazardous chemicals is unlikely, you should not expect to find perfect and complete sources of information on the alternatives appropriate for your specific applications. There are many sources of information on possible alternatives for many situations – whether in manufacturing or service operations.



Type of source	Type of information provided	Examples
Safer alternative resources	<p>Sites designed to provide information or present research on potential alternatives for hazardous chemicals in the workplace for selected sectors or applications, sometimes including extensive case study information.</p> <p>SUBSPORT (EU), IRTA (an Institute providing technical analyses of safer alternatives for California EPA and US EPA) and CatSub (EU/Denmark) all provide case studies of safer alternatives for especially wide varieties of hazardous chemicals, industries and applications. IRTA’s case studies are extensive, in-depth assessments of alternatives.</p>	<ul style="list-style-type: none"> • SUBSPORTⁱ • IRTA case studiesⁱⁱ • TURI case studiesⁱⁱⁱ • TURI CleanerSolutions database^{iv} • EPA DfE list of safer chemical ingredients^v • Catsub database^{vi}
Trade association technical information	Some trade associations provide technical information on safer alternatives for hazardous materials in production of their products.	AFIRM Supplier Toolkit (apparel sector) ^{vii}
Industry trade or other journals	Industry Trade Associations and Professional Societies publish papers that provide technical and scientific information on various topics.	Paint Pro Professional Paint & Decorating Contractors Journal ^{viii}
Manufacturer and vendor information	Chemical and chemical products manufacturers publish Product Data Sheets that give information on the physical and chemical properties of their products and application information.	Shell Solvents ^{ix}
Other companies or technical experts	<p>Obtain information on how an alternative worked in another company’s process. In cases where companies are willing to share some of the details of their implementation experience, talk to them about the challenges. Where did the alternative work and where not? What were key challenges that had to be met to make the alternative effective?</p> <p>Outside experts may also provide valuable information.</p>	Some of this information is available from case studies, proceedings of conferences and meetings
State technical assistance programs and technical libraries	Many states have pollution prevention, toxics reduction or green chemistry technical assistance programs to provide information and/or limited consulting or research support to companies seeking safer alternatives to replace hazardous chemicals. They often focus particularly on developing and sharing information on safer-alternative options for responding to new regulatory restrictions on the use of hazardous chemicals. The size and technical resources of these programs varies from state to state.	<ul style="list-style-type: none"> • Michigan Retired Engineers Technical Assistance Program (RETAP)^x • Massachusetts Office of Technical Assistance^{xi} • Minnesota Technical Assistance Program^{xii} • Washington Dept. of

Type of source	Type of information provided	Examples
	<p>Some of these state programs also have developed on-line technical libraries that include safer alternatives; these resources are often shared between states, and are available to companies anywhere.</p> <p>A list of state pollution prevention programs (with links) is available at the P2Rx website.</p>	<p>Ecology^{xiii}</p> <ul style="list-style-type: none"> • Toxic Use Reduction Institute at University of Massachusetts, Lowell^{xiv} • P2Rx links to state pollution prevention programs^{xv}
Internet research	<p>In addition to all the resources above, don't forget to do internet searches for safer alternatives. Tailor the wording of the search to zero in on the chemical you want to replace and the functionality you need to achieve with as much specificity as possible. These searches may take you to innovative approaches not yet included in some of the databases above, and provide ideas on who you should contact to get more information.</p> <p>SUBSPORT's custom search engine allows users to search multiple databases and websites related to substitution.</p>	<p>SUBSPORT's Substitution Search Engine^{xvi}</p>

The value of any particular source of information about potential safer alternatives will depend on your business, the specific application, the type of product you're manufacturing or servicing and a range of other factors. The more common the demand for alternatives – e.g., due to new regulatory restrictions on the use of the hazardous chemical – the greater the range of tested alternatives are likely to be available. Magic bullets that solve all problems are unlikely. Developing a rich set of alternatives during this step of the process will increase the likelihood that you will be able to develop an effective and protective alternative to adapt to your particular needs.

4.2 The Six TUR Techniques

Toxics can be reduced by a facility in a variety of ways, ranging from making simple operational changes to a total redesign of a production unit. TURA defines six categories of TUR techniques and as mentioned above, one useful way to identify TUR options is to consider each TUR technique separately, brainstorming as many ideas for each technique as possible.

The six TUR techniques are:

4. **Input substitution** – replacing a toxic or hazardous substance or raw material used in a production unit with a non-toxic or less toxic substance.
5. **Product reformulation** – substituting for an existing end-product an end-product which is non-toxic or less toxic upon use, release or disposal.



6. **Production unit redesign or modification** – developing and using production units of a different design than those currently used.
7. **Production unit modernization** – upgrading or replacing existing production unit equipment or methods with other equipment and methods, based on the same production unit.
8. **Improved operations and maintenance** – modifying or adding to existing equipment or methods including, but not limited to, such techniques as improved housekeeping, system adjustments, process / product inspections, or production unit control equipment or methods.
9. **In-process (integral) recycling** – recycling, reuse, or extended use of toxics by using equipment or methods which become an **integral** part of the production unit.

For the purposes of developing specific options in a given facility, you should consider whether the option achieves a *reduction* in the use of the toxic chemical or the *elimination* of the toxic chemical. All of the listed techniques allow for toxics use reduction, however, some options may better allow for eventual elimination of the chemical. For this reason all options should be considered in terms of long-term planning. For example, if a company has the long-term goal of eliminating a toxic chemical, it may not make economic sense to invest in a recycling operation for that chemical in the short term.

Along with considering all types of options, the planning team should examine all product-related activities for toxics use reduction opportunities, including product design, formulation, manufacturing, and marketing. Redesigning a product can be an effective approach to reducing or eliminating toxics use since product design affects all processes and chemical use. However, making product design changes requires involvement of design engineers, marketing personnel and others, and may require a longer implementation time than changes to a manufacturing process.

4.2.1 Input Substitution

Input substitution involves replacing a toxic or hazardous process chemical with a less hazardous or non-hazardous chemical. This technique may not reduce the volume of waste generated, but the waste generated will be less hazardous. A common example of input substitution occurs in metal parts cleaning where toxic solvents are replaced by less toxic cleaning agents. Sometimes simple detergents may suffice. Such substitutes are called **drop-in substitutes**, because they do not require any process or product modification. Other substitutes require equipment modifications. For example, helium could serve as a replacement for CFCs in refrigeration, but it would require heavier containers and tubing because of its higher operating pressure level.

1. Input Substitution

- Replacing a toxic or hazardous substance or raw material used in a production unit with a non-toxic or less toxic substance.

Examples:

- Substitute soy-based inks for petrochemical inks.
- Substitute vegetable-based fluids for oil-based cutting fluids.
- Substitute non-toxic pigments for toxic ones.

Input Substitution

Replace chemical w/ less hazardous option

- May not reduce amount of waste, but waste is less hazardous
- Drop-in substitutes don't require process changes (and are best)
- Some options may require equipment or product modification

Requires careful analysis

Potential impact on product/process quality

Input substitution requires careful analysis. One of the first considerations is the potential effect the substitute may have on product quality. Although there is a great deal of literature regarding available substitutes, caution should be applied in the face of a quick solution. An aqueous degreaser used to replace trichloromethane may be fine for one application, however, for another application, this same substitution may not yield the required results or it may increase production costs.

Another important consideration in choosing a substitute is the relative hazard of the substitute. Increasing concern over safety hazards led to the substitution of non-flammable, chlorinated solvents for flammable solvents in cleaning operations. Today we are seeking substitutes for those chlorinated solvents that have been shown to have chronic health effects. Some currently used substitutes are flammable. It is important that the next transition be toward LESS hazardous materials.

Input substitution is often highly dependent on access to information. Larger firms may be able to find chemical substitutes more easily because of their access to research or their capacity to conduct their own research. Smaller firms may be more dependent on trade associations or vendors to learn of potentially effective substitutes.

Although trade magazine case studies provide a great deal of good information on new substitutes, they do not replace the planning process. Case studies often provide a fine description of the solution, but neglect to describe the procedure involved in finding that solution. While an extensive technical evaluation should be performed on each potential TUR option, one commonly overlooked impact of input substitution bears mentioning here. Input substitution often results in the creation of a different type of byproduct that may affect a different media. For example, switching from a solvent-based to an aqueous-based cleaner could adversely affect the wastewater treatment system, cause effluent limits to be exceeded, and increase wastewater treatment sludge production.

Input substitution is an advanced TUR technique. It requires a reasonable level of effort and willingness to try new materials. Yet input substitution has potentially great economic and environmental rewards, because it directly eliminates the use of a toxic chemical.



Examples of Input Substitution

- Substitute soy-based inks for petrochemical inks.
- Substitute water-based paints for oil-based paints.
- Substitute vegetable-based fluids for oil-based cutting fluids.
- Substitute aqueous cleaners for solvents.
- Substitute powder coatings or water-based, high solids for solvent-based coatings.
- Substitute trivalent chromium for hexavalent in electroplating.
- Substitute non-mercury bactericides in paint formulation.
- Substitute non-toxic pigments for chromium-, cadmium- and tin-based pigments.

4.2.2 Product Reformulation

Product reformulation involves replacing hazardous chemicals with non-hazardous chemicals in the product design and formulation stage.

Reformulating a product to contain less hazardous materials typically results in less toxic chemical use in the process as well as in the final product.

Product reformulation requires significant attention to product quality and a clear understanding of customer requirements. If a product is reformulated, it must meet customer specifications and work as well as the product it is replacing. While product reformulation may not be feasible for every application, consumer demand for environmentally conscious products and the increase in regulations concerning product content may make product reformulation a wise business

The information exchange that takes place in product reformulation is sometimes quite sensitive. Firms in highly competitive industries that reveal the constituents of their new formulation for a product may jeopardize their competitive position. Firms may be more likely to offer information on cleaning processes, for example, than on their product formulation.

Examples of Product Reformulation

- Eliminate trimethylbenzene in a lithographic press wash product by changing the mixture of chemicals blended to make the wash.
- Eliminate solvents in polyurethane varnish by developing a water based coating for wood furniture.
- Decrease the amount of solvent needed in paint by switching to a high solids formulation.
- Negotiate with FDA for approval for a new cosmetic formula that eliminates use of a toxic chemical in the cosmetic product.
- Educate customers about the advantage of purchasing new product lines specifically designed to eliminate toxic chemical ingredients.

4.2.3 Production Unit Redesign or Modification

Production unit redesign, or process redesign, involves altering the process used to make a product in order to reduce the use of toxic process chemicals. This technique involves more than equipment modernization, because it involves the introduction of a new way to manufacture the product. This may involve new equipment or new procedures.

A good illustration is those firms that have moved from chemical cleaning operations to physical cleaning operations like buffing and sanding. Firms that have substituted high velocity, pulsating water streams for solvent baths have eliminated the need for solvent altogether. Solvents that are

2. Product Reformulation

- Reformulating or redesigning end products to be nontoxic or less toxic upon use, release or disposal

Examples:

- Decrease the amount of solvent needed to manufacture paint by switching to a high-solids formulation
- Introduce new product lines specifically designed to eliminate the use of toxic chemicals.

Production Unit Redesign or Modification

Involves altering process used to make product

New way to manufacture

New equipment

New procedures

Product Reformulation examples



Product Reformulation

Invasive step

Must meet customer performance and quality specs

Revealing reformulation info may jeopardize competitive position

3. Production Unit Redesign or Modification

- Developing and using production units of a different design than those currently used.

Examples:

- Upgrade tool and equipment quality to reduce off-spec products
- Install automatic thermostats or automatic flow controls
- Install high-performance nozzles, brushes, and applicators to conserve coatings and reduce the number of reject products

used to dry surfaces are easily replaceable with air blast systems or thermal alternatives. Through careful analysis some firms have discovered that they cleaned parts too often. The so-called "no-clean" process eliminates an operation that previously required a toxic chemical bath.

The installation of multiple rinsing tanks, dragout reclamation systems, and countercurrent rinse cleaning systems has reduced toxics use in electroplating firms. This option may require substantial redesign of the production unit and pilot runs are often required to test for changes in the quality of the product.

Significant process redesign will affect work practices and may require a redeployment of employees. Those skilled in running particular equipment may need to be retrained for different processes. Such training and redeployment costs need to be factored into the option analysis in deciding on process changes. This option may also involve a significant amount of research and capital expenditure.

Examples of Production Unit Redesign or Modification

- Eliminate unnecessary cleaning steps.
- Replace solvent cleaning operations with aqueous cleaning.
- Use high-pressure water sprays for parts cleaning.
- Install countercurrent rinsing systems to reclaim process chemicals.
- Install drip racks and dragout recovery tanks.
- Use air knives to blow solutions back into baths.
- Install paint arresters to capture paint overspraying.
- Replace solvent-based paint strippers with mechanical processes (abrasion or high velocity plastic bead guns).
- Replace dry grinding operations with wet operations to reduce dust.

4.2.4 Production Unit Modernization

Production unit modernization refers to upgrading existing production unit equipment and methods with other equipment and methods based on the same production unit. Replacing outdated and inefficient equipment with new and more modern equipment meets the definition of production unit modernization if it reduces the amount of toxic chemical use. Although this technique involves an initial capital investment, it often pays for itself fairly quickly in increased production rates, lower raw material use, and lower waste disposal costs.

Investments in higher quality tools and equipment can lead to reduced toxic chemical use. High performance nozzles in paint or water spray apparatus can better target sprays and reduce chemical waste.

Production Unit Redesign or Modification

Involves altering process used to make product

New way to manufacture

New equipment

New procedures

Production Unit Redesign examples



Production Unit Redesign or Modification

- Research success at other facilities
- May require pilot runs
- Affects employees
- May involve additional capital costs

Production Unit Modernization

Involves upgrading

- Replacing outdated equipment
- Replacing inefficient methods

Reduces toxic chemical use

Requires capital investment

4. Production Unit Modernization

- Upgrading or replacing existing production unit equipment and methods with equipment and methods of a more recent design.

Examples:

- Install countercurrent rinsing systems to reclaim process chemicals
- Use air knives to blow solutions back into baths
- Replace solvent-based paint strippers with mechanical processes

Modernization includes increasing levels of process control. Process control improvements can lead to less toxic chemical use due to less off-specification product, fewer spills and leaks, and less rework. Automated control systems can yield higher levels of efficiency in material use and less material leaving a facility as waste byproduct. Yet production unit modernization does not have to be high tech and complicated; it can be as easy as installing a thermostat to control production temperatures better.

Larger scale modernization projects require the company to carefully consider factors such as production down-time, capital availability, facility modifications, and employee training on the new equipment. Considering all of these factors, firms often find that the payback period is fairly quick, because modernization usually leads to increases in productivity as well as reduced waste and toxic chemical costs.

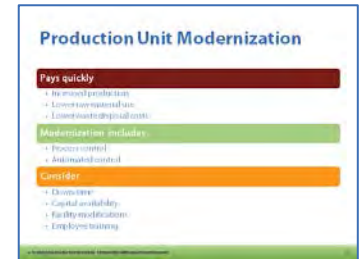

Examples of Production Unit Modernization

- Install automatic thermostats to maintain optimum process temperatures.
- Install automatic flow controls.
- Install high performance nozzles, brushes, and applicators to conserve coatings and reduce the number of reject products.
- Install timers on transfer equipment to time process schedules accurately.
- Upgrade tool and equipment quality to reduce off-spec products.
- Install seal-less pumps in place of packed or single seal types.

4.2.5 Improved Operation and Maintenance

4.2.5.1 Improving Process Maintenance

Improving the efficiency of the production unit by improving the process operation and maintenance can be one of the most cost effective ways of reducing toxics use.

Some production units may involve many operating procedures that differ from those that were originally planned. These procedures may have been adapted over the years due to variations in equipment performance, faulty equipment, or lack of training in the proper procedure. This kind of information is often well known by production line workers. During brainstorming sessions, workers on the production line should be encouraged to present process problems and explain "real" operating procedures when different from those envisioned by management.

Changing a standard operating procedure may seem simple, but it can be heavily resisted by workers if it leads to significant changes in work practices that do not seem beneficial to those who perform the tasks. If only a small savings will be realized by performing a task in a different manner, it probably is not worth making the change.

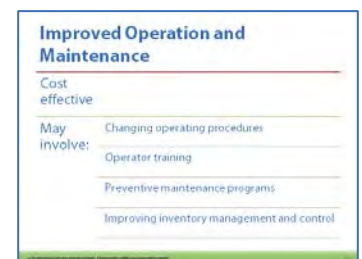
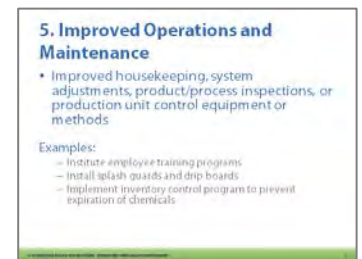

Examples of Improved Operations and Maintenance

Process Maintenance

- Tighten and repair all faucets, gaskets, and couplings to eliminate leaks.
- Institute employee training programs to encourage employee involvement in TUR programs.
- Schedule production to reduce equipment cleaning.
- Install splash guards and drip boards.
- Dedicate process equipment to a single product line.
- Minimize change-over time in batch processing to reduce drying and setting.
- Sequence batch mixes from light to dark to avoid intermediate cleaning steps.
- Inspect parts prior to processing to reduce number of rejects.
- Install lids on process tanks to reduce evaporation and spills.

Inventory Management

- Standardize paints, cleaning agents, oils, etc., to facilitate interchangeable use and reuse.
- Improve inventory control to avoid overpurchasing, material spoilage, and material obsolescence due to expired shelf life.
- Buy in bulk only where practical.
- Centralize all material purchase records to facilitate easy tracking.

Operator training can lead to reduced use of toxic chemicals. Shop floor workers often have a great ability to use materials more efficiently. Too often, workers are not adequately trained or motivated to find ways to make machines perform better.

Maintenance may be constantly reactive, involving frequent repair of broken equipment, rather than preventive maintenance. Constantly running poorly maintained equipment will reduce the efficiency of the process. While most of the techniques involved in this area are simple, they can provide significant reductions. Equipment that has not been maintained will not perform efficiently, resulting in poor quality products or wasted materials, both of which lead to increased toxic chemical use. A faulty valve or a broken seal can release large amounts of toxic chemicals over a workweek, even if the rate of flow is very low.

One very effective remedy may be the implementation of a scheduled maintenance system. This kind of program will help to assure that preventive maintenance takes place. Such a program might include:

- A list of all plant equipment and locations (demarcating critical process equipment)
- Operating time for each item (hrs/day)

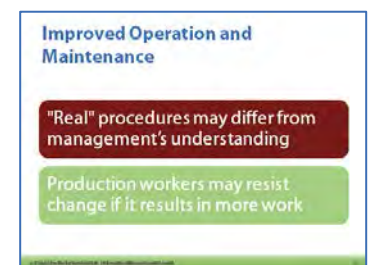

- Service history (days since last tune-up)
- Maintenance history (days since last breakdown)
- Maintenance manuals

4.2.5.2 Improving Inventory Management

Improving inventory management is a noninvasive technique that can allow for significant reductions. Two basic aspects of inventory management are inventory control and material control.

Potential Sources of Process Material Loss	
Area	Source
Loading	Leaking fill hose from line connections Draining of fill lines between fillings Punctured, leaking, or rusting containers Leaking valves, piping, and pumps Lack of training programs
Storage	Overfilling tanks Improper overflow alarms Punctured, leaking, or rusted containers Leaking transfer equipment Inadequate diking Improper transfer procedures
Process	Leaking process tanks Improperly operated and maintained process equipment Leaks and spills during material transfer Inadequate diking Equipment and tank cleaning

4.2.5.3 Inventory control

Inventory control involves buying appropriate materials at appropriate times. The shelf life of the chemical, the amount being used, the storage capabilities, and the costs of the materials should all be factors in determining effective inventory control programs.

If a toxic chemical has a very short shelf life and the chemical is used in small quantities, it is probably not prudent to buy the chemical in bulk. On the other hand, if large quantities of the chemical are used, it makes sense to buy in bulk. Bulk purchase and storage of nonperishable materials can reduce use by reducing the amount lost in transfer leaks and spills and in container residues.

Even with the above techniques, surplus inventories may still accumulate. If a raw material is beyond its shelf life, the company may consider

whether the material can be used in another process that does not require the high purity lost during extended storage.

4.2.5.4 Material control

Material control includes storage of raw materials, products, and wastes and the transfer of these materials within the production unit. Often reduction of losses in this area comes as a result of changes in operational procedures. Many losses in this area are forgotten because they occur between the warehouse and the production process. Large reductions can be achieved by proper waste handling. Waste streams should be studied to determine if wastes are being mixed or inadvertently contaminated when they could be recycled or reused within the production unit. This is one reason why the entire production unit should be considered during materials accounting.

4.2.6 Recycling

In-process recycling and reuse can be a cost-effective TUR option that can increase the reuse of a toxic chemical in such a way as to reduce the annual amount purchased and the amount discharged as a byproduct. Recycling allows for reductions in waste disposal costs as well as raw material costs.

Electroplating firms have found that plating baths can be filtered, reclaimed, and reused so as to extend the life of the baths over many months. Such techniques are sometimes referred to as “closed-loop” recycling because they result in a closed system of materials use. Standardizing solvents to reduce the number of solvents used can not only result in the elimination of some solvents from the facility, but also can make recycling a lot more practical.

In-process recycling is preferred because more efficient recovery is likely to occur at the point of generation. Collecting the waste stream outside of the process for off-site recycling does not reduce the amount of toxic chemical being used on-site or prevent exposure to workers. Off-site recycling also increases the amount of handling required. The waste must be loaded onto a truck, transported, off-loaded, recycled, and transported back to the company.

Examples of Recycling, Reuse, or Extended Use of Toxics

- Capture and recycle clean-up solvents.
- Rework batch process byproducts back into the next batch.
- Recycle and reuse spent rinse water.
- Distill and reuse solvent strippers.
- Install reverse osmosis, ion exchange, or electrolytic recovery systems for cleaning baths to increase recycling and reuse.
- Segregate byproducts to increase recoverability and reuse.

6. Recycling

- Recycling, reuse, or extended use of toxics by using equipment or methods which are integral to the process, including filtration and other closed loop methods

Examples:

- Capture and recycle cleaning solvents
- Regeneration of acid instead of disposal of acid
- Recycle and reuse spent rinse water
- Distill and reuse solvent strippers

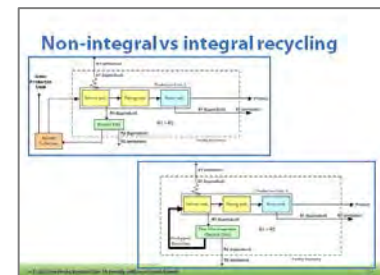

Integral Recycling examples

In Process Recycling

- “Closed-loop” recycling and reuse
- Reduces annual amount purchased and discharged
- Often a cost-effective and economically feasible option

4.3 Being Systematic

Effective toxics use reduction embraces continual improvement. Therefore, it is important to approach the process of identifying appropriate TUR opportunities systematically. Doing so ensures that subsequent TUR planning efforts can build upon previous work, and that good ideas that do not appear to be technically or economically feasible at first can be reconsidered. As technology advances, once sub-par performance options could become highly appropriate for specific purposes. And financial feasibility considerations are ever-changing as the market adjusts to new economic drivers.

When considering potential opportunities to reduce use of toxic chemicals, therefore, it is helpful to document your ideas, assumptions, information sources and criteria. In doing so, the TUR team should be certain to consider and document the factors that influence your facility's ability to implement feasible options.

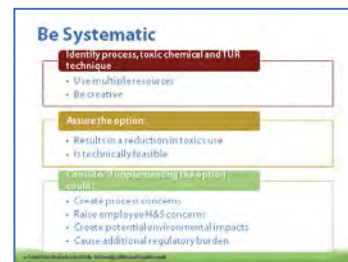

5 TUR Options Evaluation and Alternatives Assessment

Objectives: At the end of this chapter, participants will be able to:

- Consider technical, environmental and human health and safety, and economic criteria when assessing the feasibility of TUR options
- Develop appropriate screening procedures for potential TUR options
- Conduct appropriately thorough evaluations of options, including assessment of safer chemical alternatives
- Develop systematic procedures for choosing TUR options to implement.

In this module we will look at how to evaluate the options identified with the goal of finding opportunities to implement changes that allow your facility to reduce its use of toxic chemicals.

Additional attention is devoted to the case of TUR options that are associated with chemical input substitutions. In this case, the TUR options evaluation process needs to include a more thorough consideration of the environmental and human health and safety (EH&S) impacts of the alternatives being considered. This process is also referred to as Alternatives Assessment.

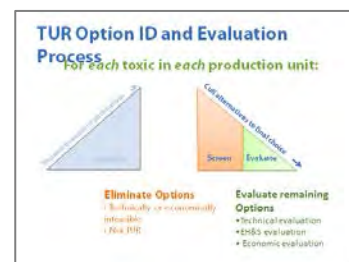

5.1 Introduction to TUR Options Evaluation

After a comprehensive list of TUR options has been developed, the next step is to evaluate the technical, economic feasibility, and overall safety of each option. This evaluation of TUR options provides the information needed to make a business case for implementing changes that will result in toxics use reduction. The process of TUR options evaluation is essentially the same as the process more commonly referred to as Alternatives Assessment. In 2014 the National Academies of Science laid out the process of alternatives assessment in its Framework to Guide Selection of Chemical Alternatives (<http://www.nap.edu/catalog/18872/a-framework-to-guide-selection-of-chemical-alternatives>).

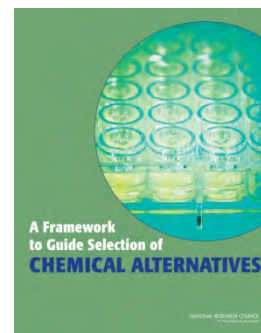

Alternatives assessment is also increasingly being incorporated into businesses' strategic decisions both nationally and globally as they work to better manage their use of chemicals. Companies like HP use this method to guide their choice of chemicals and materials, with a primary goal being to avoid highly expensive product redesigns required by potential future customer or regulatory restrictions.

The first step in assessing TUR options (alternatives assessment) is to develop criteria for screening out options that are not technically or economically feasible or that do not result in TUR.

5.2 Screening TUR Options

As described in the previous module, companies should consider options in all six TUR techniques. However, in many cases, it is not necessary to thoroughly investigate every one of the six techniques, or every TUR option the planning team identifies as a possibility. Companies can screen and immediately eliminate from further consideration any options that clearly are not technically or economically feasible, or that would not actually reduce the use of toxics or the generation of hazardous byproduct.

In fact, you might find that some options are so straightforward, inexpensive, effective, and easy to implement – so-called “low-hanging fruit” – that no further assessment is needed to implement them.

At the same time, it is important not to eliminate TUR options too hastily. Options that may seem impractical at first glance may, in fact, be successful solutions in the long run. For these reasons, it is valuable to approach TUR options selection with rigor, and to take advantage of established tools and benchmarking criteria to assist in arriving at your decision.

Qualitative considerations, such as the impact on the company's reputation with the local community, regulators and/or customers, must be included in your assessment of TUR options.

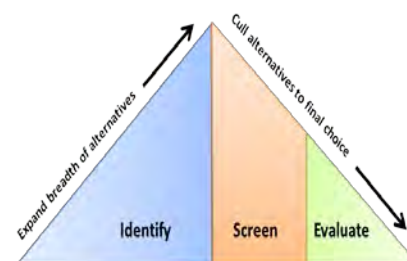

Screening TUR Options	
	Technically
	Economically
	Does it reduce toxics?
	Does it reduce byproduct?
	Don't shift the risk!

Finally, TUR options should not result in shifting risks (for example, removing toxics from the product shipped but increasing potential harm to workers by using more toxic processing chemicals that do not end up in the final product). This is, therefore, another important potential screening criterion.

Options can be evaluated either formally or informally depending on the capacity of the TUR planning team, the complexity of options being considered, and available resources. TUR options evaluation should be incorporated into the company's existing decision-making processes. For example, if your company has a rigorous procedure for considering and planning process changes, it would be advantageous to include TUR considerations into that process, even if the purpose of initiating such a project is not primarily to implement TUR. Often options may be sufficiently evaluated through discussions about the positive and negative aspects of options with a few knowledgeable employees. In the case of more complex TUR options, a more detailed and objective assessment is typically required.

Initially, it is helpful to construct a list of questions that reflect the conditions of the facility to help guide you in the screening process. Questions might include:

- What are the main benefits of this option?
- What is the TUR potential of this option?
- How old and in what condition are related buildings and equipment, and how does this relate to proposed changes?
- Does this option fit well with other company goals – such as operational efficiency or product quality?



Initial screening to eliminate obviously infeasible options allows you to focus time and energy on more promising options.

5.2.1 Technical Screening

The process for screening out TUR options that are not technically feasible should be well-considered. Develop screening criteria that relate specifically to your process, product and customer needs. Consider the entire system in which the TUR option would be applied when screening for technical feasibility. For instance, the replacement of a chemical with a less toxic chemical may initially seem incapable of achieving required performance levels but when considering the entire production process it may be possible to modify upstream process steps to accommodate the use of the option.

Examples of factors that might be appropriate technical feasibility screens could include:

- Equipment availability
- Worker skills
- The impact on product quality

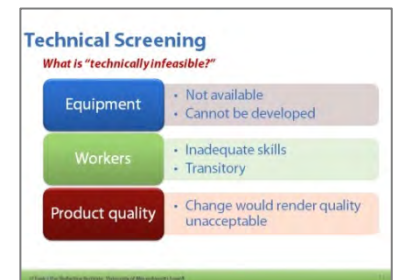

- Space availability for installation of equipment

5.2.2 Economic Screening

The financial impacts of implementing a specific TUR option are often influenced by factors that may be variable over relatively short periods of time (e.g., the price of petroleum based substitutes), or that are affected by external forces outside of your facility's control (e.g., the availability of equipment required to implement the option). As a result, an option that might appear to be economically infeasible at first may in fact become economically feasible as conditions change.

When evaluating TUR options from an economic standpoint you must be careful not to eliminate options too quickly based solely on up-front costs or a Simple Payback Period that exceeds company guidelines. Some projects with large initial investments pay for themselves quickly in overall savings and productivity improvements. It is important to carefully consider what the appropriate economic screening criteria are for your facility, and to document those in your TUR Plan. Typically, developing economic screening criteria should be done in collaboration with your facility's upper management to assure that they are as flexible as possible while accommodating the company's business model.

5.2.3 EH&S Screening

When the TUR option being considered is a substitution of one chemical for the toxic chemical, or when a product reformulation or process modification results in a change in chemistry, those chemical alternatives that are not in fact safer should be screened out. A chemical is typically considered to be "safer" if it does not exhibit environmental or human health impacts that are similar to or exceed that of the toxic chemical for which it would be substituted. The definition of "safer" also includes avoiding potential shifting of risks to workers, the public or the environment from one set of hazards to another (e.g., substituting a known carcinogen with a chemical shown to cause significant neurological impacts on workers).

The Massachusetts Toxics Use Reduction Institute (TURI) conducted a thorough assessment of chemical and material alternatives for five chemicals of concern in 2006². The EH&S screening method used by TURI for this study was to eliminate from further consideration any chemical that was present on the Science Advisory Board's list of More Hazardous Chemicals³, chemicals that were carcinogens, mutagens or reproductive toxicants (i.e., either on the European Union list of CMRs⁴ or

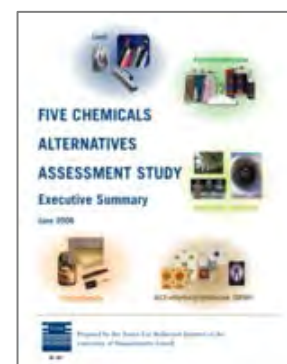
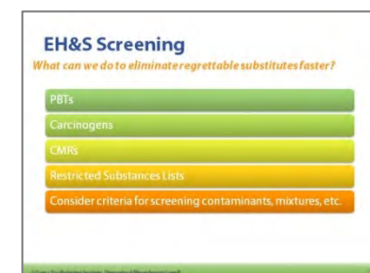
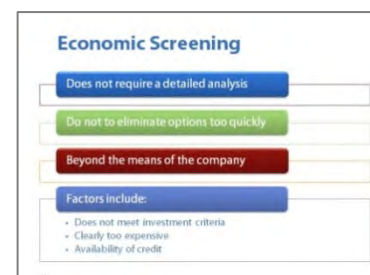

² http://www.turi.org/About/Library/TURI_Publications/2006_Five_Chemicals_Alternatives_Assessment_Study

³ http://www.turi.org/Our_Work/Toxic_Chemicals/Chemical_Lists

⁴ Chemicals known or suspected to be Carcinogenic, Mutagenic, or dangerous to Reproductive health (CMRs) are continuously being assessed by the European Chemicals Agency (ECHA). The list of chemicals under consideration is called the Community

on the State of California's Proposition 65 list⁵ or chemicals that are persistent, bioaccumulative and toxic in aquatic environments (as determined by presence on pertinent lists such as the EPA list of PBTs⁶, or by modeling using EPA's PBT Profiler.⁷

There are also many lists of chemicals that exhibit hazardous characteristics that you can use to quickly screen out potential substitutes. One list that is updated routinely and quite comprehensive is the Chemical Hazard Assessment Tool (ChemHAT), which is designed to be highly user-friendly and comprehensive, and is maintained by an alliance of labor and business organizations (the Blue-Green Alliance). There are a number of other resources that one can use to identify appropriate screening criteria. These are discussed later in this module.

The specific method your facility chooses to screen out substitutions based on EH&S considerations should be determined based on the key concerns associated with the use of the chemicals. These concerns include the hazard characteristics of the substitute as well as the occupational exposure potentials associated with the use of the chemical in your process, relevant process waste disposition, and final product use and disposition patterns.

5.3 Evaluating TUR Options

Additional investigation of TUR options done during the evaluation stage may reveal that an option is not viable at this time. However, the evaluation stage of your research may also identify new TUR options that should be considered. It is important that TUR options be evaluated using the same criteria that the company uses for other kinds of projects or expenditures.

The following sections provide guidance on the process of evaluating TUR options for technical feasibility, economic feasibility, and environmental and human health and safety (EH&S) impacts.

5.3.1 Technical Evaluation

The technical assessment determines whether equipment and materials will function as needed in specific applications. Depending on the option, a number of technical feasibility studies—from paper studies to pilot projects — may be needed. However, an exhaustive technical analysis may not always be necessary or useful. Determine a TUR option's ability to satisfy associated performance criteria typically relies on qualitative and quantitative information. The input of technical expert – both in house as

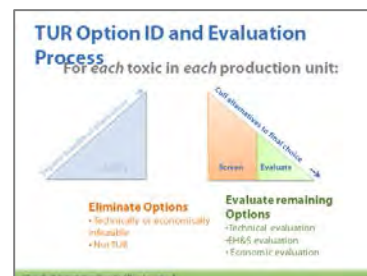
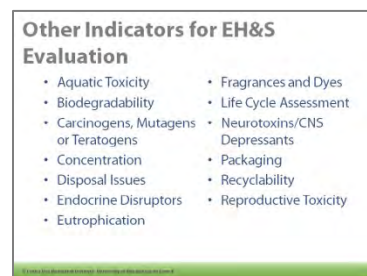

Rolling Action Plan (CoRAP), at <http://echa.europa.eu/information-on-chemicals/evaluation/community-rolling-action-plan/corap-table>

⁵ http://www.dtsc.ca.gov/SCP/upload/Informational_Initial_Candidate-Chemicals-List.pdf

⁶ <http://www.epa.gov/osw/hazard/wastemin/priority.htm>

⁷ <http://www.epa.gov/oppt/sf/tools/pbtprofiler.htm>

well as external – for guidance on the likelihood of an option being technically feasible and therefore implementable is typically required. Appropriate technical experts may include:

- Process engineers or scientists (chemists, materials scientists, etc.)
- Academic researchers who have published closely related scientific results associated with the performance criteria in question
- End users of the products or processes using the options being considered
- Marketing or sales staff familiar with customer requirements
- Consultants with expertise in similar product development

Questions to ask as you evaluate the technical feasibility of the TUR options being considered include:

1. **What are the performance needs for the application, process or product that contains the toxic chemical for which TUR options are being sought? Why is the toxic being used in this specific application?**
 - Does the chemical provide a specific function that is important for its performance?
2. **Has the TUR option already been identified as favorable with respect to performance?**
 - Is the TUR option currently being used (i.e., by other industries) for the same or similar functional application under review?
 - Is the TUR option currently used in similar products available on the commercial market?
 - Is the TUR option marketed in promotional materials as an option for providing the desired functionality for the specific application of interest?
3. **Is this option available?**
 - Is this option “off-the-shelf” technology with demonstrated successful use?
 - What is the likelihood of widespread commercialization?
 - How reliable is the new technology?
 - What is the vendor's track record?
 - Is this option applicable to my firm? Is the option being produced in sufficient quantity to meet the demand if it is used in place of the toxic?
4. **Is the option compatible with existing process technology?**
 - Are equipment, materials, or processes used in the option compatible with current procedures, work flows, and production rates?

Assessing Performance Potential

- What function does targeted hazardous chemical play in your company's product, process or service?
- Do potential alternatives adequately replace the functional performance of that hazardous chemical?



When Evaluating Technical Feasibility

- Will use of this option meet market quality demands?
- Will this option provide equal or better operational efficiency and productivity?
- Will using this option adequately ensure product durability?
- Will use of this option require substantial worker retraining?

What is “Technically Infeasible?”

Equipment	<ul style="list-style-type: none"> • Not available • Cannot be developed • Too risky
Workers	<ul style="list-style-type: none"> • Inadequate skills readily available
Product quality	<ul style="list-style-type: none"> • Change would reduce quality (unacceptable) • Decrease in quality impact / would be disruptive • Change would slow production time
Regulatory	<ul style="list-style-type: none"> • Impacts ability to meet other regs. • Unacceptable increase in regulatory burden
Facility	<ul style="list-style-type: none"> • Not enough floor space • Insufficient utilities (industrial steam, compressed air)

- Will the system installation require downtime that will interfere with the production schedule?
- How complex are the operations and maintenance requirements?
- Is floor space available?
- Are utilities available, or will they have to be installed?
- Does this option require personnel training?

5. Will product quality be affected?

- Will the defect rate increase?
- Will the finished product still comply with customer specifications?
- Will the option affect the product cosmetically?

6. Will this option be viable for a sufficiently long term?

- What is the toxics use reduction potential of this option?
- Will this option remain viable despite market and regulatory changes?
- Is it flexible/durable enough for the firm's anticipated needs?

Suppliers and industry trade associations may be able to help with information about new materials and systems. Often suppliers will allow companies to test new equipment on a trial basis or will provide bench scale or pilot scale demonstrations, or references to other customers who have implemented the technique. If you are considering changes in equipment or processes, try to visit facilities using the new equipment or process. Check the track record of the technology with operators on the floor to see how vendors' claims work out in practice.

5.3.2 EH&S Evaluation

The Massachusetts TUR program has been a key contributing model to alternatives assessment is that it reorients environmental protection discussions from problems to solutions this emerging field. The most important aspect of alternatives assessment is that it reorients environmental protection discussions from problems to solutions. For example, chlorinated solvents provide a service of degreasing and cleaning. Once we understand that it is this service that the solvent provides that we require, rather than the solvent itself, it is possible to think of a much wider range of alternatives. Options we might consider include ultrasonic cleaning, or less toxic aqueous cleaners, or even redesigning a metal part so that the need for cleaning is eliminated altogether.

5.3.2.1 Alternatives assessment process

Alternatives assessment processes can lead to innovation and produce substantial cost savings for firms as well as health and environmental benefits for society. Alternatives assessment can also be a more efficient

If you are considering a process change that involves a new piece of equipment, it is important to consider such factors as additional building services requirements (energy, water, etc.), maintenance issues, worker training needs, and ergonomic considerations.

means of reducing multiple risks in the long term. Problem-based approaches generally examine one risk or problem at a time and are met with one solution at a time. Alternatives assessment calls attention to current and “on-the-horizon” alternatives. Resources that might otherwise be directed solely to the expensive and time-consuming process of characterizing problems can then focus on solutions.

A number of states have been working together to draft common language for assessing the availability of safer alternatives for chemicals of concern. TURI led the effort by this group to create a protocol for conducting safer alternatives assessments that is being used to inform state government policies and technical assistance practices. In addition, the group has drafted a Resource Guide that provides detailed guidance on the various elements of an alternatives assessment. This Guide can be accessed through the NEWMOA website⁸.

Another excellent resource for guidance in the process of assessing alternatives is the Occupational Safety and Health Administration (OSHA)’s Transitioning to Safer Chemicals⁹ program.

For input substitution TUR options, the remaining steps in Alternatives Assessment (screening, comparing, and selecting alternatives) are the primary focus of your TUR options evaluation. Implementing and promoting the adoption of the most feasible and safest alternative(s) is done in accordance with your facility’s business strategy.

Once the “bad actor” chemicals have been screened out from further evaluation, it is important to gather sufficient additional information on possible options to evaluate if, in the case of chemical input substitution, the alternatives being considered are in fact safer than the toxic chemical currently being used.

For example, historically the chemical 1-bromopropane (otherwise known as n-propyl bromide or nPB) had been considered an appropriate and preferred alternative for things like methylene chloride in adhesives, or trichloroethylene (TCE) in vapor degreasing because it could essentially be used as a drop in replacement and, until recently, was not well regulated. However there had been very clear scientific evidence of the acute and chronic health hazards associated with exposure to nPB in the literature for decades. Companies that relied solely on regulatory lists to assess if nPB was an acceptable TUR option found themselves having to make another costly process change years later in order to achieve toxics use reduction. Had those same companies conducted a more thorough investigation of the potential hazards associated with using nPB in their facilities initially, they may have been able to make a more informed

Alternatives assessment reorients environmental protection discussions from problems to solutions



What is a “Safer Alternative”?

- A different, less hazardous chemical that achieves the same, or better, results
- An alternative material, product or process that eliminates the need for using hazardous chemical
- Re-design or reformulation of a product that eliminates need for a process or material requiring hazardous chemical
- Generally, no nirvana. ‘Safer’ an improvement over current chemical. New technologies, new knowledge lead to innovative *still safer* alternatives

⁸ <http://www.newmoa.org/prevention/ic2/aaguidance.cfm>

⁹ https://www.osha.gov/dsg/safer_chemicals/

substitution decision that would have led to a more reliable and longer term solution.

5.3.2.2 Tools for finding EH&S data

There are on-line tools available to assist in identifying any relevant regulatory and chemical restrictions on toxic chemicals. These tools, such as the ChemHAT tool¹⁰, designed for workers and freely available, and the Pharos Project¹¹, designed for building material users, specifiers and designers, and available for a nominal subscription fee, provide a good first step for determining if a potential chemical substitute should be considered further. By utilizing a number of lists as compiled in tools like ChemHAT and Pharos companies will be more likely to avoid regrettable substitutions like the example above because they wrongly assumed that the absence of a chemical alternative on a specific list is an indication that it is safer.

However, even using more lists can still lead to regrettable substitutions. If the chemical input substitution being considered is not present on any lists, companies can conduct a relatively cursory review of scientific data to identify if there are any indications for concern. The use of a Safety Data Sheets (SDS) is not intended to be a comprehensive source of information; however it does provide important information about the various hazardous constituents present in a product and the human and environmental health hazards and likely routes of exposure associated with those hazardous constituents.

The Toxics Use Reduction Institute routinely uses an assessment tool, P2OASys (which stands for Pollution Prevention Options Assessment System) to more systematically evaluate whether a potential input substitute is safer than the toxic chemical being replaced. This tool uses SDSs as well as other data sources to evaluate up to 68 criteria: from acute human health endpoints like respiratory sensitization, to physical and chemical characteristics such as flammability and vapor pressure, to process and work environment considerations such as resource use or exposure potential. The P2OASys system relies heavily on expert judgment, with guidance available on TURI's website (www.turi.org/p2oasys).

A good additional source of information on scientific studies and interpretations of studies is the Toxicology Data Network (ToxNet), maintained by the US National Library of Medicine¹². In fact, there are a great many sources of additional information that can be used to more fully characterize a chemical. The Massachusetts Toxics Use Reduction Institute has created a Library Guide for EH&S data, which can be

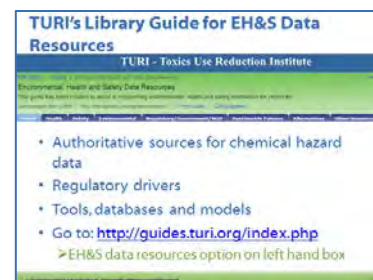
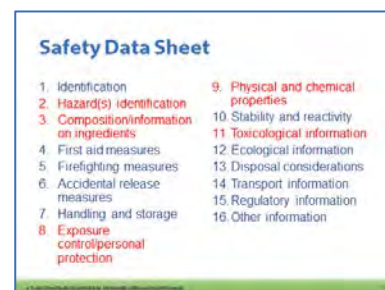
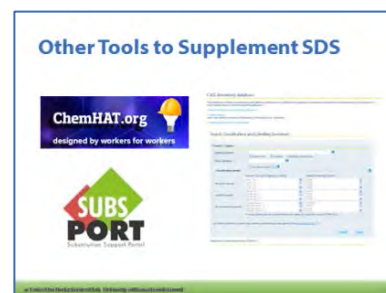

¹⁰ www.chemhat.org

¹¹ <https://www.pharosproject.net/>

¹² <http://toxnet.nlm.nih.gov/>

accessed at <http://guides.turi.org/beyondmsds>. There you can access a variety of resources for data by health, safety and environmental endpoint (e.g., carcinogenicity, flammability, persistence). There are a number of other related resources available at this site.

5.3.2.3 Input substitution considerations

As you consider the EH&S implications of a chemical input substitution option, questions to ask may include:

1. Does this option impact other Environmental, Health, or Safety requirements?

- a. Consider air and water emission permits, OSHA regulations, Chemical Process Safety Management, etc.
- b. Consider potential new byproducts and/or hazardous waste streams that may be generated.

2. Is this truly a safer input substitution?

- a. Does sufficient health, safety, and environmental data about the option exist to make a reasonable comparison?
- b. If data is unavailable or limited, are other technical methods available with which to make a reasonable estimation of the relative safety of the substance (e.g., modeling tools)?
- c. Does this option shift risk, for example by making a final product safer while adversely affecting worker health and safety during manufacture?

3. Is this option truly TUR?

- a. If implemented, would this option reduce the number and/or amounts of reportable toxic substances on Form R for this specific use?

5.3.3 Economic Evaluation

The economic evaluation is intended to determine expensive the TUR option will likely be to implement. Economic aspects of implementing a TUR option to consider include operating costs, material costs and labor costs. In addition, there are less straight-forward costs, such as potential future liability, lost productivity due to worker illness, product quality, and corporate image, which must also be considered and which may affect an option's overall economic feasibility.

A variety of methods for assessing the economic criteria are discussed in detail in Module 9: Financial Analysis. The methods of financial analysis can be used at this stage in the planning process to gauge the costs and savings associated with each option. When conducting an economic

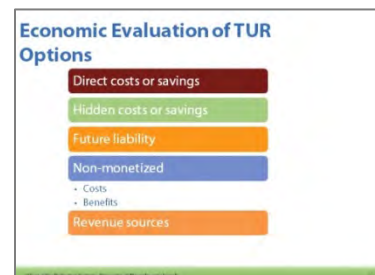

analysis, it is important to be mindful of the overall objectives – to identify TUR options that are not only economically feasible, but that also result in a less toxic process/product and that perform at least as well as the toxic being reduced.

It is important to consider *all* the potential costs and savings associated with a potential TUR option. In other words, your financial considerations must go well beyond the initial capital cost of the option. Issues to consider during an economic assessment include:

1. What are the direct costs or savings of this option?

- What capital expenditures will be needed to implement this option?
- What will it cost to operate and maintain the new system?
- What are the treatment, storage, and disposal costs?

2. What are the hidden costs or savings associated with this option?

- Can any negative cost impacts be mitigated in some way, such as through bulk purchase contracts, recycling contracts, use minimization, etc.?
- Will this option affect costs of compliance-related activities?
- Will this option decrease taxes and fees?
- Will capital and operating expenses for emergency preparedness decrease?
- Will this option reduce costs for Personal Protection Equipment, ventilation, and other worker safety requirements?
- Will there be less lost time due to accidents or exposures?
- Will Workers' Compensation premiums decrease?

3. Will this option affect future liability?

- Will there be less potential future liability for hazardous releases?
- Will liability insurance premiums decrease?
- Will potential penalties and fines be avoided?

4. Are there fewer tangible or non-monetized costs or benefits?

- Will the firm's public image be enhanced?
- Will community and employee relations be improved?

5. What new revenue sources are associated with this option?

- Will this option provide new markets for modified products?
- Does this option allow the sale or use of byproducts?
- Does this option allow the sale or use of recovered products?
- Will market share lost to competing non-toxic products be regained?

Be mindful of the overall objectives of an economic evaluation. If a given TUR option costs less to implement, but will increase worker exposure to a toxic, is it really more cost-effective?

In general, the approach for an economic evaluation is to first look at capital and operating costs and building the business case for implementing the option. However, if a project does entail significant capital costs, a more thorough economic analysis should be done that includes intangibles as well as standard costs and benefits.

One of the more difficult intangible cost factors to quantify in assessing the feasibility of toxics use reduction is the potential liability associated with continued usage of toxics. This includes the potential for reduced liability insurance premiums.

When making investment decisions, a company will determine the appropriate return on investment for a given level of risk. If it can be shown that investing in a TUR option represents a reduced level of risk, the firm may opt to reduce its return on investment requirements. This can be done by extending the acceptable payback period or reducing the required rate of return.

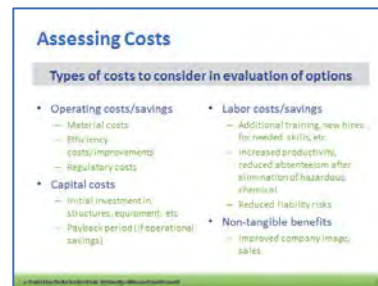

5.4 Deciding Whether to Implement a TUR Option

In comparisons of more than a very few simple criteria, some form of hierarchy among the relevant criteria is established. For example, the objective of considering implementation of a chemical substitution is to identify a “safer” alternative. Determining the specific criteria associated with health and ecological impacts that are the most relevant to your specific applications should be weighted more heavily when making decisions.

The most important aspect of any TUR options evaluation is transparency. The thought process used, including all assumptions and rationales, must be made explicit so decisions made can be clearly understood and so that future TUR options evaluations constitute continuous improvement. Without clear documentation of the decision process, you run the risk of having to duplicate effort in subsequent evaluations.

Most decisions incorporate the following steps:

- 1) Define the issue: What decision will be made based on the assessment (e.g., determination to implement a viable TUR option)?
- 2) Identify the decision making framework: Which process for arriving at decisions works best for the chemical, product or process under evaluation? What are the key criteria upon which a decision can be made for each step of the TUR Option Evaluation?
- 3) Consider the reliability of information used for each step of the TUR option evaluation: Sometimes data associated with key

elements of the TUR Option Evaluation are not available or unreliable. The quality of the information collected may be an important factor in deciding whether or not to implement a TUR option.

A number of methods can be used to address complex decisions. For example, complex decisions can be broken down into more manageable decisions in which pairs of criteria are compared in a stepwise fashion. The criteria are aggregated and these groups of criteria are compared with each other. In some applications, large numbers of criteria are compared simultaneously in a multi-criteria analysis. In this instance, the values of the criteria often need to be normalized to enhance comparison and the relative importance of each criterion, its relative weight, needs to be defined.

The Interstate Chemicals Clearinghouse (IC2) is a collaborative effort of a number of US states and municipalities interested in promoting the adoption of safer chemicals and materials. In January 2014 the IC2 released an extensive Guide for conducting alternatives assessments, which can be accessed at http://theic2.org/alternatives_assessment_guide. The Guide includes guidance on several decision-making approaches that can be used when determining which input substitutions to implement.

If your company employs a quality manager, it is likely that individual has numerous techniques for deciding on alternatives. Involving your quality manager is also a good way to incorporate TUR planning into regular operations planning.

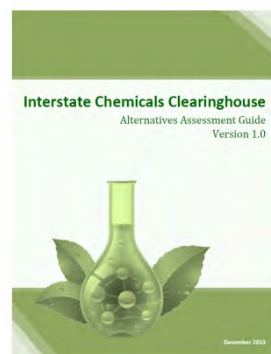

5.4.1 Less-Tangible Factors to Consider

Impacts of implementing a TUR project include effects on: product quality, productivity, public image, market share, stakeholder relations, and employee health and safety, among others.

Some of these issues, such as “public image”, tend to be straightforward: the impact of a TUR project is presumed to be positive, and the question is ‘to what extent and how quickly’. Other issues, such as product quality, may arise as unintended consequences of the effort to reduce toxics. In these cases, toxics use reduction changes may have either a positive or a negative impact. After determining the nature of the possible impact of implementation, the project team must figure out how best to communicate fully the positive benefits, or it must consider ways to restructure the project to minimize unwanted consequences.

- **Product quality:** Customers are increasingly demanding environmentally-friendly products yet are often unwilling to surrender price or quality to achieve their expectations. A TUR project that is detrimental to product quality (e.g., through inferior material substitution or process changes that fail to meet design specifications) will rapidly translate into lost sales or into increased

costs of rework and downtime. Alternatively, a TUR initiative may improve quality and/or enable a product to be marketed as ‘green’, a benefit that may engender greater market acceptance and boost sales.

- **Impact on Productivity/Capacity:** Process changes resulting from the implementation of a TUR project could potentially increase or decrease the productivity and/or effective capacity of a plant. For example, an aqueous degreaser may reduce solvent use but may require a longer cycle time to effectively remove contaminants and dry sufficiently for subsequent process steps, thereby increasing throughput time and lowering productivity. On the other hand, installing new equipment to add a parallel process line might both reduce solvent use required for product changeovers and increase production capacity.
- **Employee health and safety:** Improving working conditions can have both substantial short and long-term benefits, including lower worker compensation rates due to safer conditions, lower health care payments, increased productivity, reduced absenteeism and reduced OSHA regulatory oversight. Combining equipment/process specifications with occupational health and safety data can provide documentation of expected improvements in working conditions. These short term benefits are only part of the value to workers, who can experience health impacts decades after first starting to use certain toxic chemicals. A company’s commitment to the long term health of their employees can be a powerful talent retention tool, as well as being a strong statement of social responsibility.
- **Pro-active environmental strategy:** Environmental regulation shows a clear trend toward increasingly stringent limitations for contaminants in air emissions, wastewater, and hazardous waste. TUR projects have the ability, inherent in their prevention philosophy, to position a company to meet or surpass projected future toxic use and discharge limits. A strong argument for a TUR project is its capacity to alleviate such unknown factors as purchase price, disposal costs, or new health issues that accompany the use of substances known to be environmentally damaging. A project team can mention these issues in a project justification packet and point to proposed new regulations or regulatory trends to support their arguments.
- **Public image:** The importance of an environmentally-correct image has greatly increased in the past decade, and many companies now tout their ‘green’ credentials. While a good public image is important for its own intangible reasons, its value is increasing as the link between a company’s public image and

market acceptance of its products becomes stronger. Image can be especially important to a company that has suffered a poor environmental reputation. Although almost any pollution prevention project can bolster the environmental record of a business, one that directly addresses a publicly-recognized problem can be especially valuable. If a proposed TUR project eliminates a source of bad publicity, such as the discharge of effluent that discolors a waterway, the public relations benefits of the project should be strongly emphasized in the justification package.

- **Market share (i.e., consumer acceptance):** Numerous surveys have documented the trend of “green” consumerism, and companies have responded by emphasizing environmental attributes in new product development. The growing inclination of consumers to buy “green” refers to purchases of products or services that are environmentally-benign or that are offered by companies with good environmental records. This phenomenon goes beyond consumer purchasing, and is now a very relevant component of institutional purchasing. Massachusetts has an Environmentally Preferred Purchasing list of vendors and products that should be preferentially chosen by state agencies and institutions that is based on their “greener” footprint. A TUR project that ‘creates’ a green process or product may have a significant impact on sales, depending upon customer demand. A project justification proposal could promote the value of this factor by including survey data related to the particular industry or product type.
- **Stakeholder relations:** The term “stakeholders” can broadly include almost any person, group or organization with which a business has contact: employees, stockholders, lending institutions, customers, suppliers, surrounding communities and others. The benefits of a TUR project may affect relationships with these groups in different ways, such as public image, employee health and safety, and market share. Generally, most firms place increased importance on the value of being recognized as a “good neighbor”. If this is an important issue to the company, it should be mentioned as part of the justification argument in a project proposal.

5.4.2 Potential Financial Liability

The financial liability from using and disposing of hazardous substances is potentially unlimited. One of the greatest benefits of a pollution prevention strategy is its capacity to reduce exposure to potential liability. Financial liability may be associated with:

- Disposal
- Storage

One of the greatest benefits of a pollution prevention strategy is its capacity to reduce exposure to potential liability.

- Transportation
- Real property damage
- Civil actions
- Toxic tort suits
- Fines/penalties

5.4.3 Pilot Testing TUR Options

After carefully considering the TUR options that have been identified, the goal is to choose at least one action to implement that will result in a reduction in toxic chemical use. However, the work that has been done to this point has been limited to an “academic” exercise that draws from the best available information to arrive at an informed decision. What has not been determined, however, is if the TUR option chosen will work as expected. Therefore, and particularly when considering TUR options that could result in potential impacts on product quality, process efficiency, or worker health and safety, or when considering implementing options that require significant capital expenditures, conducting a smaller scale pilot test of the option is advised.

Pilot test provide an opportunity to collect relevant data about the TUR option. Pilot test may reveal unanticipated benefits, such as improved throughput efficiencies, as well as unexpected challenges, such as throughput bottlenecks impacting subsequent process steps. If unintended problems occur, pilot test results offer the opportunity to modify your approach in order to achieve success.

Questions that should be considered in the piloting process include:

- Does the TUR option perform as expected
- Are there an improvements or negative impacts on working conditions
- Are workers able to meet the needs of the new process or is additional training required
- Is product quality impacted
- Are there any regulatory implications associated with the TUR option that hadn’t been anticipated

Once the pilot testing is completed and any necessary modifications have been identified you can now scale up to full implementation of the TUR option.

5.5 Making the Business Case for Implementing TUR Options

Carefully considering the possible TUR options, and choosing to implement those that achieve TUR while protecting the overall competitive advantage of your company’s business is an important part of company strategies. It is essential to make the case to decision makers in

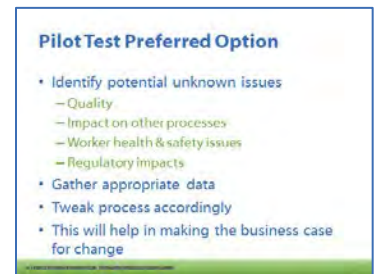

your organization that implementing TUR options that have been carefully vetted is in the best interest of the company.

To do this, you must identify your company's strategic business priorities and determine how implementation of the TUR option fits into those priorities. Often the best way to convince a decision maker who may not be well versed in the environmental and human health benefits of reducing toxic chemicals that implementing a TUR option would represent a sound business decision is relate implementation to the financial benefits.

Potential benefits of implementing TUR include:

- Reduced risk to workers, and risk of potential future liabilities
- Reduced costs for exposure control (e.g., personal protective equipment for workers and othe engineered controls associated with hazardous byproduct emissions)
- Reduced hazardous waste management and permitting costs
- Potential reduction in insurance rates associated with creating a safer workplace, and reducing potential for liability associated with unintended releases of hazardous chemicals
- Improved worker safety and enhanced worker productivity and motivation
- Improved public relationships with neighbors, regulators, and other stakeholders
- Marketing potential for your safer "greener" product or process.



SOURCES and ENDNOTES

- *Alternatives Assessment Reference Guide*, Interstate Chemicals Clearinghouse, 2013, available at: <http://www.newmoa.org/prevention/ic2/aaguidance.cfm>
- *Practical Guide to TUR*, Massachusetts Office of Technical Assistance, 1992.
- *Improving Your Competitive Position: Strategic and Financial Assessment of Pollution Prevention Projects*, Northeast Waste Management Officials Association, 1994
- *Facilitation at a Glance*, GoalQPC, ISBN: 978-1-57681-104-7

ⁱ <http://www.subsport.eu/case-stories-database>

ⁱⁱ Institute for Research & Technical Assistance, <http://www.irta.us/reports.htm>

ⁱⁱⁱ Toxics Use Reduction Institute case studies, http://www.turi.org/TURI_Publications/Case_Studies

^{iv} <http://www.cleanersolutions.org/>

^v EPA Design for the Environment program, list of safer chemical ingredients, <http://www.epa.gov/dfe/saferingredients.htm#more>

^{vi} Catsub, an EU database of substitution case studies created by the Danish Working Environmental Authority, <http://www.catsub.eu/>

^{vii} AFIRM Supplier Toolkit, <http://www.afirm-group.com/wp-content/uploads/2013/11/AFIRMSupplierToolkit.pdf>

^{viii} [Paint Strippers - PaintPRO Magazine](#)

^{ix} Proxitol Glycol Ethers, Shell Global; [Methyl PROXITOL \(PM\) Propylene Oxide Glycol Ether - Shell Global](#)

^x Retired Engineers Technical Assistance Program, Michigan Department of Environmental Quality; http://www.michigan.gov/deq/0,4561,7-135-70153_70155_3585_4848---CI,00.html

^{xi} Massachusetts [Office of Technical Assistance and Technology \(OTA\)](#)

^{xii} Minnesota Technical Assistance Program University of Minnesota; [About Us | Minnesota Technical Assistance Program](#)

^{xiii} Washington State Department of Ecology; [Technical Assistance | WA State Dept. of Ecology](#)

^{xiv} Toxic Use Reduction Institute Library, University of Massachusetts, Lowell; [TURI Publications / TURI - TURI - Toxics Use Reduction Institute](#)

^{xv} <http://www.p2rx.org/programs/index.cfm?pageAction=searchByProgramType&ProgramTypeID=2&Format=WDDX®ion=0>

^{xvi} <http://www.subsport.eu/search-substitution-db>

Acme Electronics Overview

Acme Electronics is an electronics contract manufacturer (ECM) that assembles completed circuit boards for other companies. For example, Acme is under contract to Pretty Good PCs to manufacture motherboards for PGPC's products. PGPC designs the circuitry and the board layouts, specifies the components, and establishes the tests that Acme must perform. From PGPC's designs, Acme

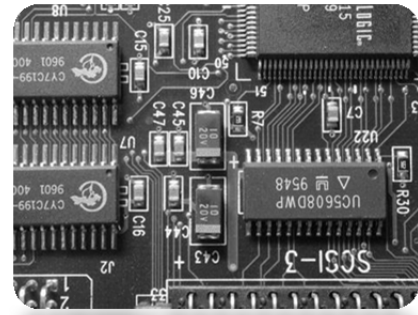

manufactures the bare circuit boards, solders all the components onto those boards, and tests them for correct operation before shipping them to PGPC. Acme is paid a set price per functioning motherboard, so their profit increases the more they can reduce the cost of manufacture.

One such manufacturing cost is cleaning solder flux from completed circuit boards. When circuit boards are manufactured, a bare board – usually some sort of fiberglass or resin surface – is 'printed' with copper or gold circuit traces in a manner quite similar to ink being applied to the surface of a paper to create a drawing. These traces thus serve as the 'wires' that connect things together according to the circuit design. Electronic components are then soldered to these traces with metallic solder that attaches them electrically to the traces where they are meant to connect. Here is how that is done:

- The bare circuit boards – i.e., the unpopulated boards that are etched with the circuit traces – are manufactured at another Acme Electronics facility and shipped to this plant for component assembly. For quality assurance purposes, each bare board is hand wiped with acetone as it is loaded onto the assembly line to assure that it is clean and free of foreign substances such as buffing compound and etch chemical residues. The facility uses 15,000 lbs of acetone per year in this application.
- A thin layer of solder paste is squeezeed onto the board. The paste has the consistency of peanut butter, and is composed of a viscous carrier of flux which has small balls of solid metallic solder suspended in it.
- A pick-and-place machine precisely places components where they are supposed to go – they stick in place because the solder paste acts as a sort of temporary glue.
- The board, now populated with electronic components, is conveyed through a 'reflow oven', which warms it to a temperature sufficient to melt the solder balls in the paste. The role of the flux is to help the metallic solder flow more easily, and helps the melted solder to adhere to the metallic surfaces of the electronic components and the board traces, so that it is repelled from the non-metallic surface sections of the board.

- The board is then allowed to cool and the flux residues are cleaned off. The final product is a completely assembled circuit board.

Acme cleans off the solder flux using n-propyl bromide (nPB). The reflowed boards are sprayed with nPB, allowed to rest a few seconds for the nPB to dissolve the flux, then sent through an air flow to blow off the flux. The facility uses 45,000 pounds of nPB per year.

Acme's workers in the flux cleaning area have complained of neurologic issues such as dizziness and memory loss since using the nPB flux cleaner. At the same time new scientific information on the hazards of nPB continues to emerge. In addition, new regulatory restrictions are being implemented at many of Acme's facilities. For these reasons, Acme is interested in reducing or eliminating its use of nPB.

1. Based on this process overview, create a process flow diagram for the solder flux cleaning process.

Worksheet for Data Collection – nPB Flux Remover

1. Using the attached Safety Data Sheet (SDS) for the Acme nPB flux remover, identify (on the following worksheet):
 - Ingredients
 - Related hazards
 - Health effects (acute/immediate and chronic)
 - Most dangerous routes of exposure
 - Precautions for working with it
 - Physical characteristics/hazards of concern to workers
2. Would you recommend continued use of this flux remover?
3. Go to ChemHAT (www.chemhat.org) and gather additional information on nPB (CAS # 106-94-5), using the following worksheet)
4. What additional information did you gather from ChemHAT that you did not obtain from the SDS?
5. What information did you gather from the SDS that you did not obtain from ChemHAT?

Data Gathering Worksheet

Category	SDS	ChemHAT
Chemical Ingredients		
Acute Health Hazards		
Chronic Health Hazards		
Routes of Exposure		
Health-Based Regulatory Limits		
Recommended or Required Exposure Controls/Protective Equipment		
Other information		

Safety Data Sheet (SDS)

OSHA HazCom Standard 29 CFR 1910.1200(g) and GHS Rev 03.

Reviewed on 06/01/2015

1 Identification• **Product identifier**• **Trade name:**• **Product description***Metal Cleaner, Degreaser & Flux Remover*

Product Name	Part No.	Packaging	National Stock No.
	0338-55	55 Gal Drum	6850-01-450-6160
	0338-5	5 Gal Pail	6850-01-450-6162
	0338-1	4 x 1 Gal Case	6850-01-450-6165

• **Details of the supplier of the safety data sheet**• **Manufacturer/Supplier:**

.....
 1A

5 EST)

• **Emergency telephone number:**

Inside the U.S.: 800-5

2 Hazard(s) identification• **Classification of the substance or mixture**

GHS08 Health hazard

Carc. 2 H351 Suspected of causing cancer.
 Repr. 1B H360 May damage fertility or the unborn child.
 STOT RE 2 H373 May cause damage to organs through prolonged or repeated exposure.



GHS07

Skin Irrit. 2 H315 Causes skin irritation.
 Eye Irrit. 2A H319 Causes serious eye irritation.
 STOT SE 3 H335-H336 May cause respiratory irritation. May cause drowsiness or dizziness.

• **Label elements**• **GHS label elements**

The substance is classified and labeled according to the Globally Harmonized System (GHS).

• **Hazard pictograms**

GHS07



GHS08

• **Signal word Danger**

(Contd. on page 2)

uS

Safety Data Sheet (SDS)

OSHA HazCom Standard 29 CFR 1910.1200(g) and GHS Rev 03.

Reviewed on 06/01/2015

Trade name: :

Hazard-determining components of labeling:*n-Propyl Bromide**propan-1-ol**1,2-epoxybutane**2-methylpropan-2-ol***Hazard statements***Causes skin irritation.**Causes serious eye irritation.**Suspected of causing cancer.**May damage fertility or the unborn child.**May cause respiratory irritation. May cause drowsiness or dizziness.**May cause damage to organs through prolonged or repeated exposure.***Precautionary statements***Do not breathe mist/vapors/spray.**Use only outdoors or in a well-ventilated area.**Wear protective gloves.**Wear eye protection / face protection.**Wash thoroughly after handling.**Obtain special instructions before use.**Do not handle until all safety precautions have been read and understood.**If in eyes: Rinse cautiously with water for several minutes. Remove contact lenses, if present and easy to do. Continue rinsing.**Specific treatment (see supplementary first aid instructions on this Safety Data Sheet).**IF INHALED: Remove victim to fresh air and keep at rest in a position comfortable for breathing.**Call a poison center/doctor if you feel unwell.**IF exposed or concerned: Get medical advice/attention.**If skin irritation occurs: Get medical advice/attention.**If eye irritation persists: Get medical advice/attention.**Get medical advice/attention if you feel unwell.**If on skin: Wash with plenty of water.**Take off contaminated clothing and wash it before reuse.**Store locked up.**Store in a well-ventilated place. Keep container tightly closed.**Dispose of contents/container in accordance with local/regional/national/international regulations.***Classification system:****NFPA ratings (scale 0 - 4)**

Health = 1

Fire = 0

Reactivity = 0

HMIS-ratings (scale 0 - 4)

Health = *1

Fire = 0

Reactivity = 0

Hazard(s) not otherwise classified (HNOC): None knownus
(Contd. on page 3)

Safety Data Sheet (SDS)

OSHA HazCom Standard 29 CFR 1910.1200(g) and GHS Rev 03

Reviewed on 06/01/2015

Trade name:

3 Composition/information on ingredients· **Chemical characterization: Mixtures**· **Description:** Mixture of substances listed below with nonhazardous additions.· **Dangerous Components:**

Proprietary organic acid blend

CAS: 106-94-5 n-Propyl Bromide > 93%

RTECS: TX 4110000 Flam. Liq. 2, H225; Carc. 18, H350; Repr. 18, H360; STOT RE 2, H373; Skin Irrit. 2, H315; Eye Irrit. 2, H319; STOT SE 3, H335-H336

CAS: 71-23-8 propan-1-ol < 4%

RTECS: UH 8225000 Flam. Liq. 2, H225; Eye Dam. 1, H318; STOT SE 3, H336

CAS: 75-65-0 2-methylpropan-2-ol < 1.5%

RTECS: EO 1925000 Flam. Liq. 2, H225; Acute Tox. 4, H332; Eye Irrit. 2A, H319; STOT SE 3, H335

CAS: 106-88-7 1,2-epoxybutane < 1.5%

RTECS: EK 3675000 Flam. Liq. 2, H225; Carc. 2, H351; Acute Tox. 4, H302; Acute Tox. 4, H312; Acute Tox. 4, H332; Skin Irrit. 2, H315; Eye Irrit. 2A, H319; STOT SE 3, H335; Aquatic Chronic 3, H412

4 First-aid measures· **Description of first aid measures**· **General information:**

Symptoms of poisoning may even occur after several hours; therefore medical observation for at least 48 hours after the accident.

· **After inhalation:**

Supply fresh air and to be sure to call for a doctor. In case of un-consciousness, place patient securely on side position for transportation. If breathing stops administer artificial respiration immediately and seek medical attention immediately.

· **After skin contact:**

Immediately wash with water and soap and rinse thoroughly, launder contaminated clothing before re-use.

· **After eye contact:**

Rinse opened eye, including under eyelids, for at least 15 minutes under running water. Remove contact lenses if present and easy to do. If symptoms persist, consult a doctor.

· **After swallowing:** Rinse mouth, DO NOT induce vomiting, immediately consult a doctor.· **Information for doctor:**

Inadvertent inhalation of vomited material may seriously damage the lungs. The danger of this is greater than the risk of poisoning through absorption. The stomach should only be emptied by a doctor and after the installation of an airway to protect the lungs.

· **Most important symptoms and effects, both acute and delayed:**

No further relevant information available.

· **Indication of any immediate medical attention and special treatment needed**

No further relevant information available.

US

(Contd. on page 4)

Safety Data Sheet (SDS)

OSHA HazCom Standard 29 CFR 1910.1200(g) and GHS Rev 03.

Reviewed on 06/01/2015

Trade name:

5 Fire-fighting measures

- **Extinguishing media**
- **Suitable extinguishing agents:**
For small (incipient) fires, use regular foam, water fog, carbon dioxide or dry chemical. For large fires apply water from afar away as possible using very large quantities (flooding) applied as a mist or spray; solid streams of water may be ineffective. Cool affected containers with flooding quantities of water.
- **Special hazards arising from the substance or mixture**
Material forms a flammable mixture with air in a narrow flammability range (3.8% – 7.5% by volume). Containers exposed to flame or high heat may explode. In fire, toxic gases may be released. Use water to cool containers exposed to fire.
- **Advice for firefighters** Keep fire exposed containers cool with water.
- **Protective equipment:**
Wear self-contained breathing apparatus (SCBA) pressure-demand (NIOSH approved or equivalent), and full protective gear to prevent contact with skin and eyes.

6 Accidental release measures

- **Personal precautions, protective equipment and emergency procedures**
Wear appropriate chemical protection equipment i.e. gloves, face shield, goggles and suitable body protection to prevent contamination of skin, eyes and personal clothing.
- **Environmental precautions:** Do not allow to enter sewers / surface or ground water.
- **Methods and material for containment and cleaning up:**
Absorb with liquid-binding material (i.e. sand, diatomite, acid binders, universal binders, sawdust). Dispose contaminated material as waste according to section 13. Ensure adequate ventilation.
- **Reference to other sections**
See Section 7 for information on safe handling.
See Section 8 for information on personal protection equipment.
See Section 13 for disposal information.

7 Handling and storage

- **Handling:**
- **Precautions for safe handling**
Ensure good ventilation/exhaustion at the workplace, avoid breathing fumes, gas, mist, vapors and sprays. Wear protective gloves, goggles and clothing. No eating or smoking in the work area.
- **Information about protection against explosions and fires:**
Keep protective respiratory device available.
- **Conditions for safe storage, including any incompatibilities**
- **Storage:**
- **Requirements to be met by storerooms and receptacles:**
Store in a cool, dry place. Store in a well ventilated place. Keep containers tightly closed.
- **Information about storage in one common storage facility:** Store locked up.
- **Further information about storage conditions:** Keep receptacle tightly sealed.
- **Specific end use(s)** No further relevant information available.

US
(Contd. on page 5)

Safety Data Sheet (SDS)

OSHA HazCom Standard 29 CFR 1910.1200(g) and GHS Rev 03.

Reviewed on 06/01/2015

Trade name: _____™

8 Exposure controls/personal protection

- **Additional information about design of technical systems:** No further data; see section 7.

- **Control parameters**

All ventilation should be designed in accordance with OSHA standard (29 CFR 1910.94). Use mechanical (general) ventilation for storage areas. Use appropriate ventilation as required to keep Exposure Limits in Air below TLV & PEL limits.

- **Components with occupational exposure limits:**

- **106-94-5 n-Propyl Bromide**

- TLV Long-term value: 0.5 mg/m³, 0.1 ppm

- **71-23-8 propan-1-ol**

- PEL Long-term value: 500 mg/m³, 200 ppm

- REL Short-term value: 625 mg/m³, 250 ppm

- Long-term value: 500 mg/m³, 200 ppm Skin

- TLV Long-term value: 246 mg/m³, 100 ppm

- **75-65-0 2-methylpropan-2-ol**

- PEL Long-term value: 300 mg/m³, 100 ppm

- REL Short-term value: 450 mg/m³, 150 ppm

- Long-term value: 300 mg/m³, 100 ppm

- TLV Long-term value: 303 mg/m³, 100 ppm

- **106-88-7 1,2-epoxybutane**

- WEEL Long-term value: 2 ppm

- **Additional information:** The lists that were valid during the creation of this SDS were used as basis.

- **Exposure controls**

Ensure adequate ventilation especially in confined areas, ensure eye wash stations and safety showers are close to work stations.

- **Personal protective equipment:**

- **General protective and hygienic measures:**

Keep away from foodstuffs, beverages and feed. Immediately remove all soiled and contaminated clothing and wash before reuse. Wash hands before breaks and at the end of work. Store protective clothing separately. Avoid contact with the eyes and skin.

- **Breathing equipment:**

In case of intensive or longer exposure use respirators and components tested and approved under appropriate government standards such as NIOSH (US) or CEN (EU).

- **Protection of hands:**



Protective gloves

Use gloves when contact with material may occur. Viton, laminate film, PVA or Silvershield gloves offer the best protection. DO NOT use natural rubber gloves when handling this product. Nitrile, neoprene or butyl gloves offer less protection and should be used for splash protection only.

(Contd. on page 6)

us

Safety Data Sheet (SDS)

OSHA HazCom Standard 29 CFR 1910.1200(g) and GHS Rev 03.

Reviewed on 06/01/2015

Trade name:**Eye protection:**

Tightly sealed goggles or safety glasses with side shields

9 Physical and chemical properties**Information on basic physical and chemical properties****General Information****Appearance:****Form:**

Liquid

Color:

Clear, Water-like

Odor:

Characteristic

Odor threshold:

Not determined.

pH-value:

Not determined.

Change in condition**Melting point/Melting range:**

-110 °C (-166 °F) (-166 °F)

Boiling point/Boiling range:

71 °C (160 °F) (160 °F)

Flash point:

Not applicable.

Flammability (solid, gaseous):

Not applicable.

Ignition temperature:

Not determined.

Decomposition temperature:

Not determined.

Auto igniting:

Not determined.

Danger of explosion:

Product does not present an explosion hazard.

Explosion limits:**Lower:**

3.8 Vol %

Upper:

7.5 Vol %

Vapor pressure @ 20 °C (68 °F):

111 mm Hg

Density @ 20 °C (68 °F):1.323 g/cm³ (11.03 lbs/gal)**Relative density**

Not determined.

Vapor density

>1.0 (air = 1)

Evaporation rate @ 20 °C (68 °F)

4 (n-BuAc = 1)

Solubility in / Miscibility with**Water @ 20 °C (68 °F):**

Negligible

Partition coefficient (n-octanol/water): Not determined.**Viscosity:****Dynamic:**

Not determined.

Kinematic:

Not determined.

Other information

VOC Content

1103 g/l

(Contd. on page 7)

us

Safety Data Sheet (SDS)

OSHA HazCom Standard 29 CFR 1910.1200(g) and GHS Rev 03.

Reviewed on 06/01/2015

Trade name:

10 Stability and reactivity

- **Reactivity** No further relevant information available.
- **Chemical stability** Stable under normal conditions.
- **Thermal decomposition / conditions to be avoided:**
Extremely high temperatures, contact with incompatible materials.
- **Possibility of hazardous reactions** Hazardous polymerization does not occur.
- **Conditions to avoid** Extreme heat, flame and ignition sources.
- **Incompatible materials:**
Certain plastics and rubber.
Strong acids, strong bases, strong oxidizing agents and strong reducing agents.
Will react with alkali, avoid contact with aluminum, tin, zinc, halogenated solvents, strong oxidizers and acids. Certain plastics and rubber.
- **Hazardous decomposition products:**
Oxides of carbon, Hydrogen bromide, carbon monoxide, smoke, fumes and/or unburned hydrocarbons.

11 Toxicological information

- **Information on toxicological effects**
- **Acute toxicity:**
- **LD/LC50 values that are relevant for classification:**
 - 106-94-5 n-Propyl Bromide**
Inhalative LC50 14 h 253 mg/l (rat)
 - 71-23-8 propan-1-ol**
Oral LD50 1,870 mg/kg (rat)
Dermal LD50 5,040 mg/kg (rabbit)
 - 75-65-0 2-methylpropan-2-ol**
Oral LD50 3,500 mg/kg (rat)
 - 106-88-7 1,2-epoxybutane**
Oral LD50 500 mg/kg (rat)
Dermal LD50 2,100 mg/kg (rabbit)
- **Primary irritant effect:**
 - **on the skin:** Irritant to skin and mucous membranes.
 - **on the eye:** Irritating effect.
- **Sensitization:** Sensitization possible through skin contact.
- **Additional toxicological information:**
- **Carcinogenic categories**
- **IARC (International Agency for Research on Cancer)**
 - Group 1 - Carcinogenic to humans
 - Group 2A - Probably carcinogenic to humans

(Contd. on page 8)

us

Safety Data Sheet (SDS)

OSHA HazCom Standard 29 CFR 1910.1200(g) and GHS Rev 03.

Reviewed on 06/01/2015

Trade name:

Group 2B - Possibly carcinogenic to humans
 Group 3 - Not classifiable as to its carcinogenicity to humans
 Group 4 - Probably not carcinogenic to humans

106-88-7 1,2-epoxybutane

2B

· **NTP (National Toxicology Program)**

106-94-5 n-Propyl Bromide

R

· **OSHA-Ca (Occupational Safety & Health Administration)**

None of the ingredients are listed.

12 Ecological information

- **Toxicity** The hazards for the aquatic environment are unknown.
- **Aquatic toxicity:** No further relevant information available.
- **Persistence and degradability** No further relevant information available.
- **Behavior in environmental systems:**
- **Bioaccumulative potential** No further relevant information available.
- **Mobility in soil** No further relevant information available.
- **Additional ecological information:**
- **General notes:**
Do not allow product to reach ground water, water course, dry creek beds or sewage system. Danger to drinking water if even small quantities leak into the ground.
- **Results of PBT and vPvB assessment**
- **PBT:** Not applicable.
- **vPvB:** Not applicable.
- **Other adverse effects** No further relevant information available.

13 Disposal considerations

- **Waste treatment methods**
- **Recommendation:**
Must not be disposed of together with household garbage. Do not allow product to reach sewage or any water system. HYPERSOLVE liquid is to be disposed of according to local, state, federal and international regulations. Offer surplus and non-recyclable solutions to a licensed disposal company.
- **Uncleaned packagings:**
- **Recommendation:**
Disposal must be made according to official regulations. Drums should be re-used, recondition, pressure tested by licensed re-conditioner. Pails should be vented and thoroughly dry prior to crushing and/or recycling.

14 Transport information

- **UN-Number**
- **DOT, ADR, ADN, IMDG, IATA** Non-Regulated Material

(Contd. on page 9)

us

Safety Data Sheet (SDS)

OSHA HazCom Standard 29 CFR 1910.1200(g) and GHS Rev 03.

Reviewed on 06/01/2015

Trade name:

- **UN proper shipping name**
DOT, ADR, ADN, IMDG, IATA Non-Regulated Material
- **Transport hazard class(es)**
DOT, ADR, ADN, IMDG, IATA Non-Regulated Material
- **Class**
Non-Regulated Material
- **Packing group**
DOT, ADR, IMDG, IATA Non-Regulated Material
- **Environmental hazards:** Not applicable.
- **Special precautions for user** Not applicable.
- **Transport in bulk according to Annex II of MARPOL73/78 and the IBC Code** Not applicable.
- **Transport/Additional information:**
- **DOT** DOT Packaging Exceptions (49 CFR 173.xxx): 150
DOT Packaging Non Bulk (49 CFR 173.xxx): 203
DOT Packaging Bulk (49 CFR 173.xxx): 242
- **UN "Model Regulation":** -

15 Regulatory information

- **Safety, health and environmental regulations/legislation specific for the substance or mixture**
- **Sara**
- **Section 355 (extremely hazardous substances):**
None of the ingredients are listed.
- **Section 313 (Specific toxic chemical listings):**
75-65-0 2-methylpropan-2-ol
106-88-7 1,2-epoxybutane
- **TSCA (Toxic Substances Control Act):**
All ingredients are listed.
- **California Proposition 65**
- **Chemicals known to cause cancer:**
None of the ingredients are listed.
- **Chemicals known to cause reproductive toxicity for females:**
106-94-5 n-Propyl Bromide
- **Chemicals known to cause reproductive toxicity for males:**
106-94-5 n-Propyl Bromide
- **Chemicals known to cause developmental toxicity:**
106-94-5 n-Propyl Bromide

(Contd. on page 10)

us

Safety Data Sheet (SDS)

OSHA HazCom Standard 29 CFR 1910.1200(g) and GHS Rev 03.

Reviewed on 06/01/2015

Trade name**· Carcinogenic categories****· EPA (Environmental Protection Agency)**

None of the ingredients are listed.

· TLV (Threshold Limit Value established by ACGIH)

71-23-8 propan-1-ol

A4

75-65-0 2-methylpropan-2-ol

A4

· NIOSH-Ca (National Institute for Occupational Safety and Health)

None of the ingredients are listed.

· GHS label elements

The substance is classified and labeled according to the Globally Harmonized System (GHS).

· Hazard pictograms

GHS07 GHS08

· Signal word Danger**· Hazard-determining components of labeling:***n*-Propyl Bromide

propan-1-ol

1,2-epoxybutane

2-methylpropan-2-ol

· Hazard statements

Causes skin irritation.

Causes serious eye irritation.

Suspected of causing cancer.

May damage fertility or the unborn child.

May cause respiratory irritation. May cause drowsiness or dizziness.

May cause damage to organs through prolonged or repeated exposure.

· Precautionary statements

Do not breathe gas/mist/vapors/spray.

Use only outdoors or in a well-ventilated area.

Wear protective gloves.

Wear eye protection/ face protection.

Wash thoroughly after handling.

Obtain special instructions before use.

Do not handle until all safety precautions have been read and understood.

If in eyes: Rinse cautiously with water for several minutes. Remove contact lenses, if present and easy to do. Continue rinsing.

Specific treatment (see supplementary first aid instructions on this Safety Data Sheet).

IF INHALED: Remove victim to fresh air and keep at rest in a position comfortable for breathing.

Call a poison center/doctor if you feel unwell.

IF exposed or concerned: Get medical advice/attention.

If skin irritation occurs: Get medical advice/attention.

If eye irritation persists: Get medical advice/attention.

Get medical advice/attention if you feel unwell.

(Contd. on page 11)

us

Safety Data Sheet (SDS)

OSHA HazCom Standard 29 CFR 1910.1200(g) and GHS Rev 03.

Reviewed on 06/01/2015

Trade name:*If on skin: Wash with plenty of water.**Take off contaminated clothing and wash it before reuse.**Store locked up.**Store in a well-ventilated place. Keep container tightly closed.**Dispose of contents/container in accordance with local/regional/national/international regulations.***• National regulations:***The product is subject to be classified according with the latest version of the regulations on hazardous substances.***• State Right to Know***All ingredients are listed.***• Chemical safety assessment: A Chemical Safety Assessment has not been carried out.****16 Other information**

The information and recommendations in this safety data sheet are, to the best of our knowledge, accurate as of the date of issue. Nothing herein shall be deemed to create warranty, expressed or implied, and shall not establish a legally valid contractual relationship. It is the responsibility of the user to determine applicability of this information and the suitability of the material or product for any particular purpose.

• Date of preparation / last revision 06/01/2015**• Abbreviations and acronyms:***ADR: The European Agreement concerning the International Carriage of Dangerous Goods by Road**ADN: The European Agreement concerning the International Carriage of Dangerous Goods by Inland Waterways**IMDG: International Maritime Code for Dangerous Goods**DOT: US Department of Transportation**IATA: International Air Transport Association**ACGIH: American Conference of Governmental Industrial Hygienists**EINECS: European Inventory of Existing Commercial Chemical Substances**ELINCS: European List of Notified Chemical Substances**CAS: Chemical Abstracts Service (division of the American Chemical Society)**NFPA: National Fire Protection Association (USA)**HMIS: Hazardous Materials Identification System (USA)**LC50: Lethal concentration, 50 percent**LD50: Lethal dose, 50 percent**Flam. Liq. 2: Flammable liquids, Hazard Category 2**Acute Tox. 4: Acute toxicity, Hazard Category 4**Skin Irrit. 2: Skin corrosion/irritation, Hazard Category 2**Eye Dam. 1: Serious eye damage/eye irritation, Hazard Category 1**Eye Irrit. 2: Serious eye damage/eye irritation, Hazard Category 2**Eye Irrit. 2A: Serious eye damage/eye irritation, Hazard Category 2A**Carc. 1B: Carcinogenicity, Hazard Category 1B**Carc. 2: Carcinogenicity, Hazard Category 2**Repr. 1B: Reproductive toxicity, Hazard Category 1B**STOT SE 3: Specific target organ toxicity - Single exposure, Hazard Category 3**STOT RE 2: Specific target organ toxicity - Repeated exposure, Hazard Category 2**Aquatic Chronic 3: Hazardous to the aquatic environment - Chronic Hazard, Category 3*

Acme Electronics

TUR Options Identification

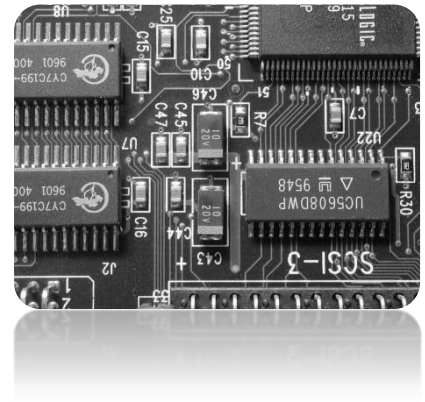

Acme now wants to find a replacement for nPB cleaning.

1. In your group, brainstorm at least one potential TUR option for each of the six TUR techniques.
2. Where would you go (i.e., what resources would you use) to gather more information?

TUR Technique	Options for Reducing Use of nPB
Input Substitution	
Product Reformulation	
Production Unit Redesign/Modification	
Production Unit Modernization	
Improved Operations and Maintenance	
Recycling which is integral to the process	

Acme Electronics

TUR Options Evaluation – Performance and Cost

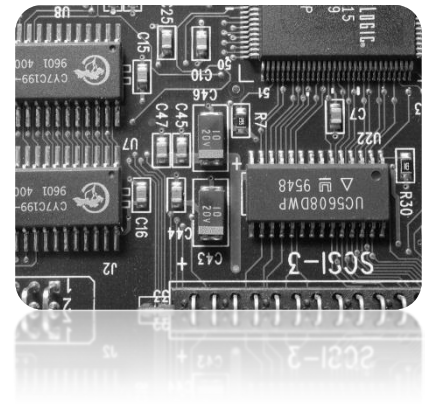

Consider the following in your small groups (estimate 15 min for performance and 15 min for cost evaluations):

1. List key performance criteria that should be considered as you further evaluate the technical feasibility of the TUR options identified above.
 - a. Who from your team should be part of this step of the TUR planning process?
 - b. Where would you look to find information to assess these criteria?
2. What are your preferred options for further evaluation? Why?
3. What options do you consider to be “clearly technically infeasible”? Why?

Potential cost-related elements suggested in TUR Options ID screening:

- nPB Use
 1. Purchase records indicate that Acme currently uses about 18,000 lbs of nPB yearly (approximately 30 55-gallon drums).
 2. Last year, according to purchase records, the hazardous waste hauler processed 15,563 lbs of nPB-related hazardous waste, which includes flux residues and nPB 'dragout'.

- Recycling and Hazardous Waste Management
 1. The current nPB cleaning system captures used solvent as liquid, separates out waste flux (which includes some nPB 'dragout'), and hard-pipes filtered nPB back into the cleaning process.
 2. Some nPB is lost as fugitive air emissions.
 3. Waste flux is treated as a hazardous byproduct by Acme.
 4. Sometimes, the cleaning station operator needs to use a brush to dislodge larger or sticky flux residues. These brushes are replaced approximately monthly and managed as hazardous waste.

- Regulatory considerations
 1. nPB is regulated as a reproductive or developmental toxic in the EU. It is not currently regulated as a hazardous substance by the US EPA.
 2. nPB is on the REACH Substances of Very High Concern (SVHC) candidate list.
 3. EPA has announced they may propose a rule that would make nPB unacceptable as an aerosol solvent or adhesive carrier.
 4. EPA recommendations also call for maximum production rate of 10 ft. per minute through nPB cleaning operations.

- Worker exposure, health and safety.
 1. The current Threshold Limit Value (TLV), as recommended by the American Conference of Industrial Hygienists (ACGIH) for nPB exposure is 10 ppm, but ACGIH has announced its intention to change it to 0.1ppm. Currently the California Occupational Safety and Health board limits nPB exposure to 5 ppm.
 2. nPB has a vapor pressure of 110.8 mm Hg at 20°C
 3. Current worker protection controls for nPB exposure at Acme include a local ventilation system in the board cleaning area. The ventilation system vendor specifies and warrants performance of nPB emissions at or below 1 ppm at operator position when used with a ventilator face velocity of 135 ft./min. – nearly the maximum velocity achievable by this system. This was verified by direct measurement 1 month after ventilation system installation. The cost to purchase and install this ventilation system cost \$13,000 when the facility was first built. Similar systems would be required for each new production line if any were to be built. Estimated capital costs for new systems would be about 20% more at current prices.
 4. Other PPE includes flexible laminate gloves, aprons, and goggles for workers near the board cleaning station.

- Workmen's Comp Insurance:

1. A recent Continuing Education Conference presentation suggests that current premiums could be reduced 75-80% if VOC 's were eliminated from operations.
2. After a spill of nPB two years ago, which required suspending operations for that shift, Acme's insurance agent sent a warning that Acme could be assigned to a high risk pool if it happens again. This would increase premiums by as much as 40%.
3. Acme responded to the spill by implementing a more robust and vigorous spill prevention and response procedure. Management decided not to communicate this with the insurance agent, reasoning that it was best not to raise the issue further.

- Sales and supply chain requirements:

1. Acme's sales department has enticed two large, well-known computer manufacturers, Pendragon & Hipplewhite (P&H) and Swell Computer Corp., into considering Acme as a supplier of PC motherboards. Either of these deals would increase production volume by over 100% within 1 year, and management is confident that it could ramp up production fast enough to meet this demand. Since the existing production line is running near capacity, procuring either of these deals would involve duplicating the existing production unit. Sufficient floor space exists.
2. The key considerations for acquiring these deals are Acme's ability to maintain product quality and production level if they get the new business.
3. Both potential customers are subscribers to the EPEAT Standard (Electronic Product Environmental Assessment Tool) and the European Computer Manufacturers Association (ECMA) Eco-declaration. EPEAT requirements include compliance with the EU RoHS Directive, reduction of substances on the EU REACH Candidate List of SVHCs, and eliminating or reducing all brominated and chlorinated flame retardant content of printed circuit board laminates
4. Swell Computer requires that suppliers provide a Materials Declaration that indicates conformance with RoHS and REACH restrictions. Suppliers must provide the amounts of REACH SVHCs and RoHS substances that are present in the articles they supply.
5. P&H is a major user of Green Screen to evaluate substances, and requires supplier to certify that their products contain no substances with a Green Screen benchmark score of 1.

- Miscellaneous considerations

1. A recent Crain's Business article profiling Acme was very favorable, noting the company's high profitability relative to the industry.
2. Acme is currently privately held, and so does not have to disclose financial information to the public.
3. The owners have said that an IPO (Initial Public Offering of shares) is a possibility in order to fund future growth. If they issue an IPO, employees would have the option to purchase shares at a discount relative to the IPO issue price.



Materials Accounting Problem Solutions

Problem 1: Product impurity concentration - Solution

$$2000 \text{ tons} \times 2000 \text{ lbs/ton} \times 56 \times 10^{-6} = 224 \text{ lbs.}$$

Yes, since this amount of lead is greater than the threshold, it must be reported.

Problem 2: Byproduct Calculation- Solution

Given

$$R1 = 10,000 \text{ lbs}$$

$$A2 = R1 \times 5.0\% = 500 \text{ lbs}$$

$$R2 = R1 \times 80\% = 8,000 \text{ lbs}$$

$$P = 4,500 \text{ lbs}$$

Equations

$$S = P + R2 = 12,500 \text{ lbs}$$

$$A1 = S \times 20\% = 2,500 \text{ lbs}$$

$$B1 = R1 - R2 - A2 = 1,500 \text{ lbs}$$

Byproduct

$$\begin{aligned} \text{Byproduct} &= R1 + A1 \\ &= 12,500 \text{ lbs} \end{aligned}$$

Emissions

$$\begin{aligned} \text{Emissions} &= A1 + A2 + B1 \\ &= 4,500 \text{ lbs} \end{aligned}$$

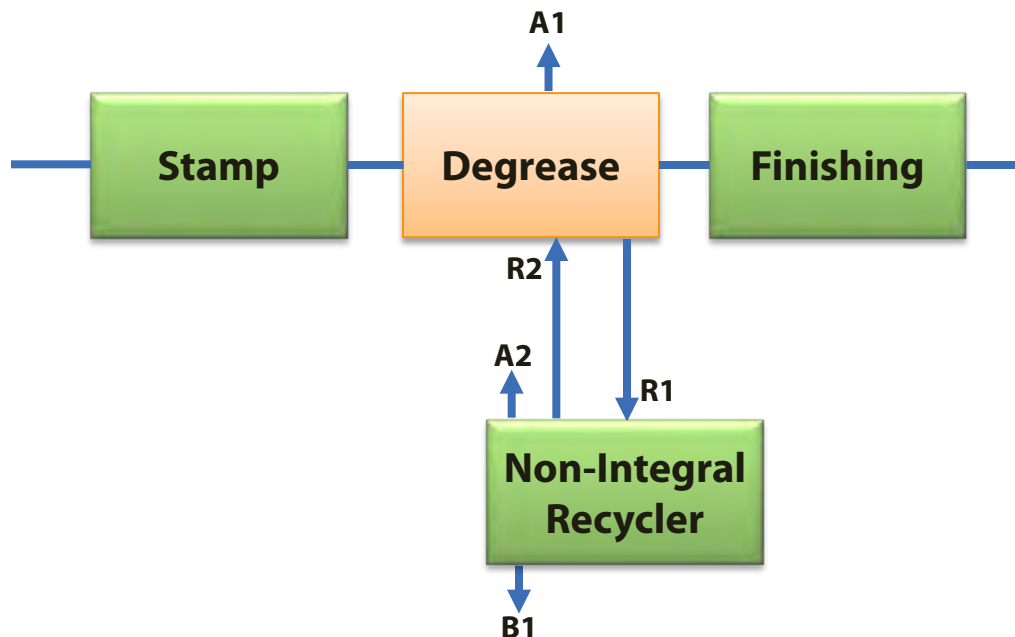

- A1 – Fugitive emissions
- A2 – Fugitive emissions
- B1 – Incinerated solvent
- R1 – Spent solvent to recycler
- R2 – Recycled solvent
- P – Purchased solvent
- S – Solvent used in degreaser

Problem 3: Back-Calculating Byproduct from Treatment Records

$$M_{\text{Byproduct}} = M_{\text{Effluent}} + M_{\text{Sludge}}$$

$$M_{\text{sludge}} = (30 \text{ lb/gal})(600 \text{ gal/yr})(40\%) = 7,200 \text{ lb/year}$$

$$\begin{aligned} M_{\text{Effluent}} &= (0.030 \times 10^6 \text{ gal/day})(255 \text{ days/yr})(2.8 \text{ part}/10^6 \text{ part})(8.34 \text{ lb/gal}) \\ &= 179 \text{ lb/year} \end{aligned}$$

$$\begin{aligned} M_{\text{Byproduct}} &= M_{\text{Effluent}} + M_{\text{sludge}} \\ &= 7,400 \text{ lbs/year} \end{aligned}$$

Problem 4: Non-Integral Recycling - Solution

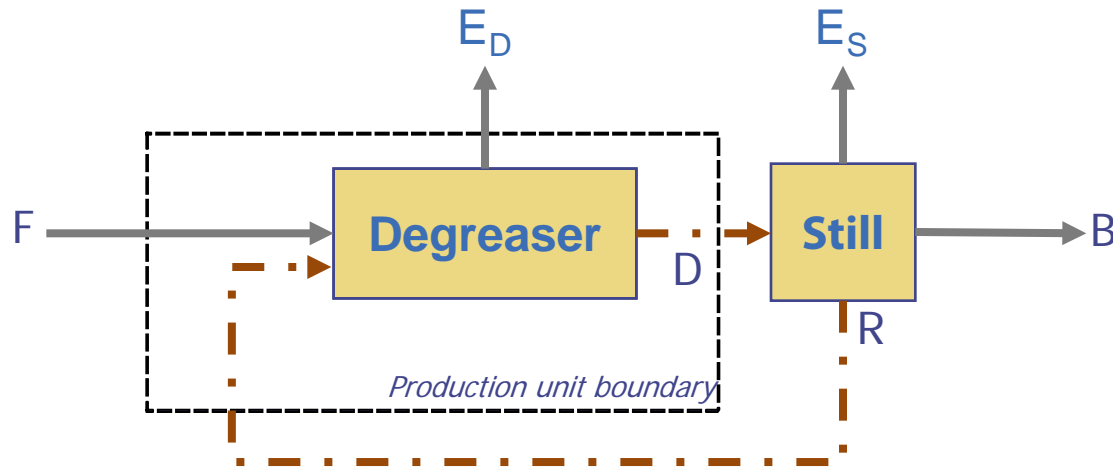

GIVEN

$$F = 8,000 \text{ lb}$$

$$R = 2,000 \text{ lb}$$

$$E_D = 0.75 * (F + R)$$

$$E_S = 0.15 * D$$

Production Unit Balance

$$F = B + E_D + E_S$$

Degreaser

$$D = F + R - E_D$$

Still

$$B = D - R - E_S$$

5 equations, 4 unknowns:

$$E_D = (0.75)(10,000 \text{ lb}) = 7,500 \text{ lb}$$

$$D = 10,000 - 7,500 \text{ lb} = 2,500 \text{ lb}$$

$$E_S = (0.15)(2,500 \text{ lb}) = 375 \text{ lb}$$

$$B = 2,500 \text{ lb} - 2,000 \text{ lb} - 375 \text{ lb} = 125 \text{ lb}$$

Problem 5: Byproduct from a Known Reaction - Reportable Amounts

HCl reacts with NaOH to produce H₂O & NaCl

If the amount of NaOH is *not* sufficient to neutralize the amount of HCl, un-neutralized HCl will remain

The reaction amounts can be calculated from known inputs of NaOH and HCl

Reportable HCl use: 15,000 lbs (given)

Reportable NaOH use: 1,500 lbs (given)

HCl neutralized: 1370 lbs (from chemical equation – see next slide)

**Reportable HCl byproduct = (15,000 lb HCl in) – (1,370 lb HCl neutralized) =
13,600 lb HCl**

NaCl is not a listed chemical

Problem 5: Byproduct from a Known Reaction - Solution

Reaction equation:

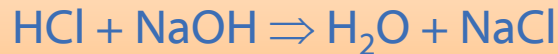

i.e., one mole HCl reacts with one mole NaOH to create 1 mole H₂O and 1 mole NaCl

$$1500 \text{ lb NaOH} \times \frac{\cancel{\text{lb - mol NaOH}}}{40 \cancel{\text{ lb NaOH}}} \times \frac{36.5 \text{ lb HCl}}{\cancel{\text{lb - mol HCl}}} \times \frac{1 \cancel{\text{ lb - mol HCl}}}{1 \cancel{\text{ lb - mol NaOH}}}$$

= 1370 lb HCl neutralized
(calculated to 3 significant figures)

$$\text{Reportable byproduct} = (15,000 \text{ lb HCl in}) - (1,370 \text{ lb HCl neutralized}) = 13,600 \text{ lb HCL}$$



Materials Accounting Problems

Michigan DEQ Training
August 20, 2015



© Toxics Use Reduction Institute University of Massachusetts Lowell

Problem 1: Product impurity concentration

Scrap tires are ground up to create crumb rubber, which is used as cushioning infill in artificial turf fields, as filler in paving material, as filler in molded and extruded products, and for a variety of other uses.

Sample testing of manufactured crumb rubber indicates that there is a concentration of 56 ppm of Lead (Pb) in the product. If 2000 tons of crumb rubber are produced in a year, how much Lead is processed? Does this amount need to be reported under TRI? (The reporting threshold for Lead is 100 lbs.)

Problem 2: Byproduct Calculation

Calculate the Total Byproduct and Emissions

Production Unit B is a vapor degrease operation. The company purchased 4,500 lbs of TCE to operate this production unit for one year. The fugitive emissions from the degreaser (A1) were determined to be 20% of the amount of TCE used in the degreaser. The fugitive emissions from the recycler (A2) were determined to be 5.0% of the TCE sent to the recycler. The spent TCE sent from the degreaser to the recycler was 10,000 lbs for the year. The recycling process recovered 80% of the TCE that was sent to it.

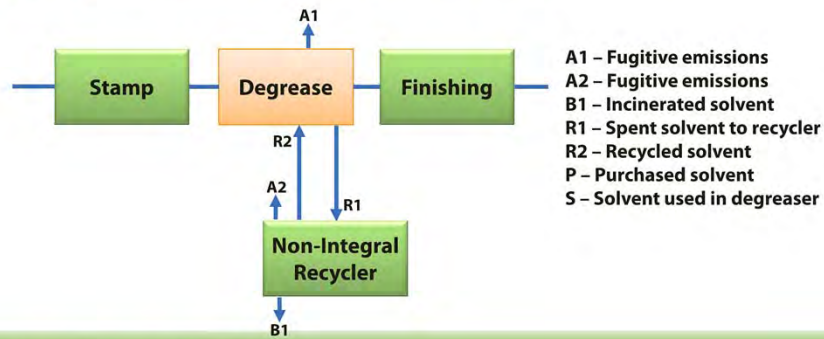

© Toxics Use Reduction Institute University of Massachusetts Lowell

Problem 3: Back-Calculating Byproduct from Treatment Records

Calculate the annual byproduct generation of copper

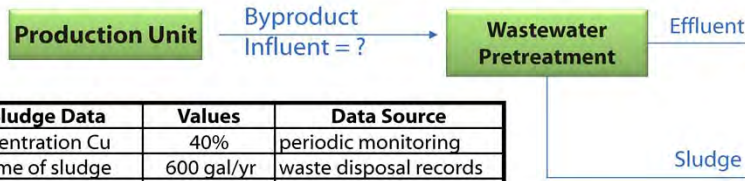

Sludge Data	Values	Data Source
concentration Cu	40%	periodic monitoring
volume of sludge	600 gal/yr	waste disposal records
density of sludge	30 lb/gal	lab results
Effluent Data		
Cu conc. in effluent	2.8 ppm	monitoring
avg flow of effluent	0.030 MGD	POTW, flow meter

Assumptions

- Concentration by weight
- Volume includes all constituents, not just copper
- Production time is 255 days/year

Problem 4: Byproduct from a Known Reaction



Determine the resulting byproduct if 1500 lb of NaOH is added to:
15,000 pounds of HCl

	Quantity added (lb)	M.W. (lb/lb-mol)
Base (NaOH)	1500	40.0
Acid (HCl)	15,000	36.5

Problem 5: Non-integral Recycling

One production unit at a facility is a toluene degreasing step. Fresh toluene is added to an open-top degreaser at a rate of 8000 lb/yr. 75% of the total toluene input is lost to evaporation, the rest is sent to a non-integral recycling still. 2,000 lb/yr of recycled toluene from the still is added back to the degreaser. The still loses 15% of the total in it to evaporation. The still bottoms are sent off-site as hazardous waste. The process is at steady state.

- a. Draw a process flow diagram of this production unit.
- b. Calculate the total emissions and total byproducts from this production unit.



Introduction to Toxics Use Reduction



© Toxics Use Reduction Institute, University of Massachusetts Lowell

Potential environmental and health risks

Serious illnesses and early mortality from occupational exposure to hazardous chemicals well documented

Environmental damage resulting in impacts to the ecosystem, drinking and surface waters, and air.



© Toxics Use Reduction Institute, University of Massachusetts Lowell

Hazardous chemicals used routinely in workplace

Removing paint with methylene chloride-based stripper



Cleaning with antimicrobial products

Dry cleaning with t-bromopropane



Using hair smoothing products containing formaldehyde

© Toxics Use Reduction Institute, University of Massachusetts Lowell

Increasing numbers, volumes of chemicals in commerce

- Volume of chemical production rapidly increasing—\$1.2 trillion increase in value of US chemical output between 2000-2020
- Number of chemicals and chemical products increasing—24,000 chemicals added to EPA's TSCA inventory since 1982
- Many chemicals manufactured/used in workplace **not adequately tested** for health impacts

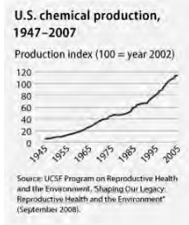

Source Reduction

- Reducing the hazards present in products and processes is the most efficient means of reducing risk to workers, the environment and consumers
- Source Reduction includes
 - Pollution prevention
 - Increased process efficiency
 - Resource conservation
 - Toxics use reduction

What is Toxics Use Reduction?

In-plant changes in production processes or raw materials that **reduce, avoid, or eliminate the use** of toxic or hazardous substances or generation of hazardous byproducts **per unit of product**, so as to **reduce risks to the health of workers, consumers, or the environment.**

Forms of Pollution Control

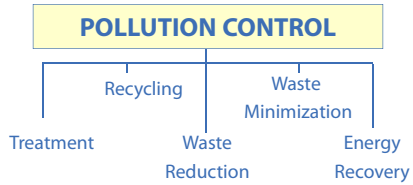

Pollution Prevention vs Pollution Control

Pollution Prevention = greater efficiency with less or no toxic material
Pollution Control = end of pipe mediation

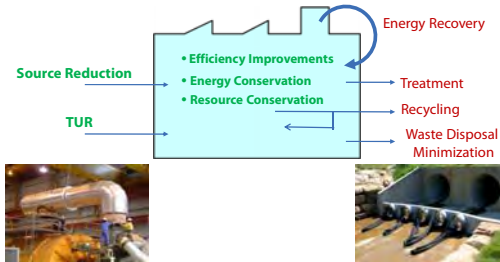

TURA and the P2 Hierarchy

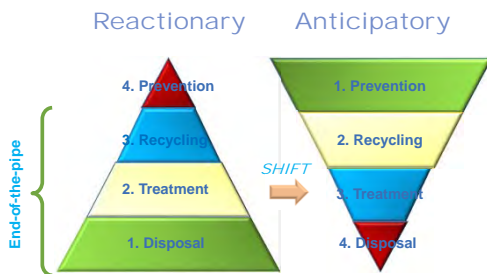

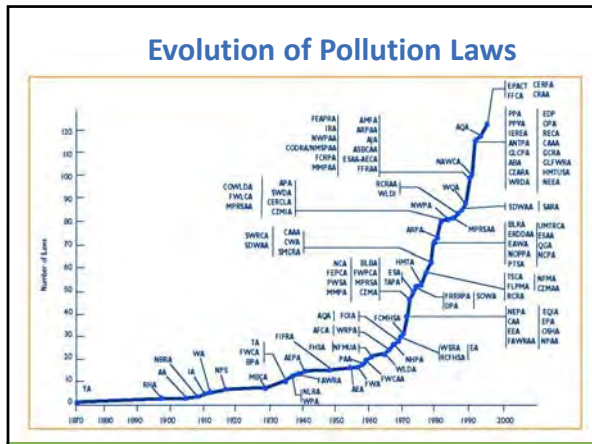

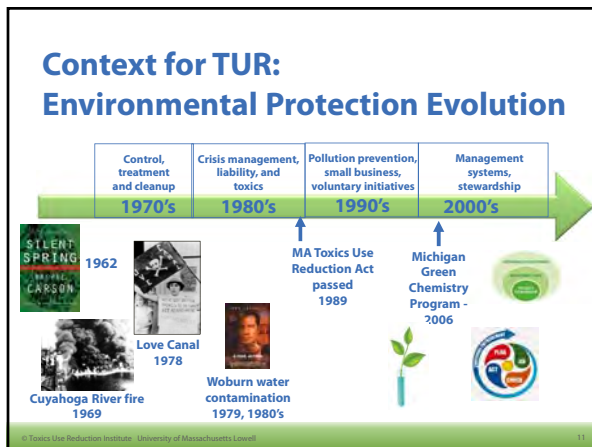

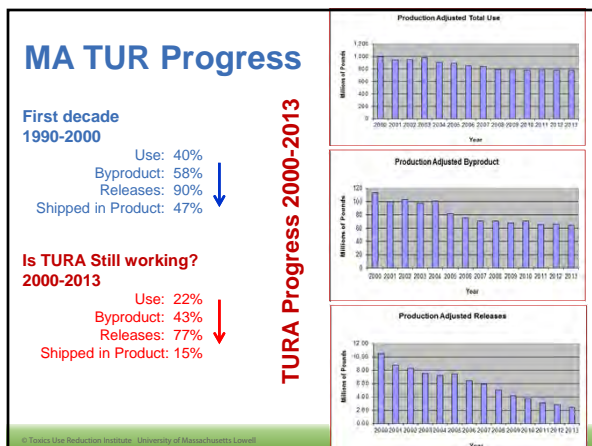

Incentives for TUR

Identifies process or chemical inefficiencies

Identifies potential cost savings

Provides a systematic materials tracking program

TUR planning methods can provide a foundation for future EMS or ISO programs

The Six TUR Techniques

1. Input Substitution

2. Product Reformulation

3. Production Unit Redesign/Modification

4. Production Unit Modernization

5. Improved Operations and Maintenance

6. Recycling which is integral to the process

TUR Planning Process

- Planning viewed as a continual improvement cycle

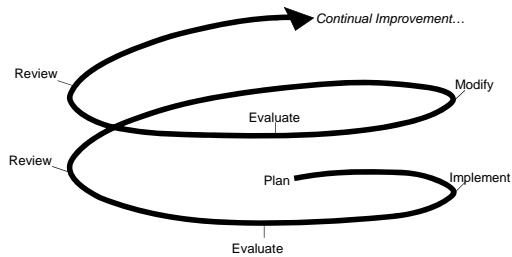

I have always found that plans are
useless, but planning is
indispensable.

Dwight D. Eisenhower





Process Characterization: *Process Mapping*



© Toxics Use Reduction Institute, University of Massachusetts Lowell

What's Involved?

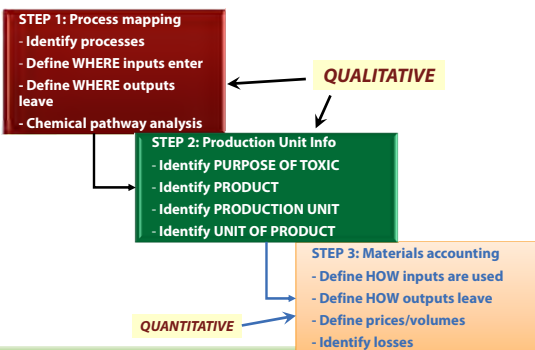

© Toxics Use Reduction Institute, University of Massachusetts Lowell

Why Do Process Characterization?

Pinpoints where wastes originate

Helps determine true costs of toxics

Helps to identify TUR opportunities

Provides basic "unit of analysis"

© Toxics Use Reduction Institute, University of Massachusetts Lowell

Process Characterization

The method by which a process or series of processes are broken down into smaller components

- Identify inputs and outputs
- Degree of dissection dependent on the needs of the analysis

➔ PROCESS FLOW DIAGRAM

What is a Process Flow Diagram?

Schematic depiction of essential processes required to operate the plant.

Tells nothing about physical layout of the operations – they are not floor plans.

Basic Block

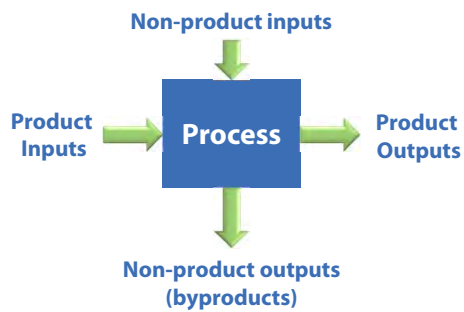

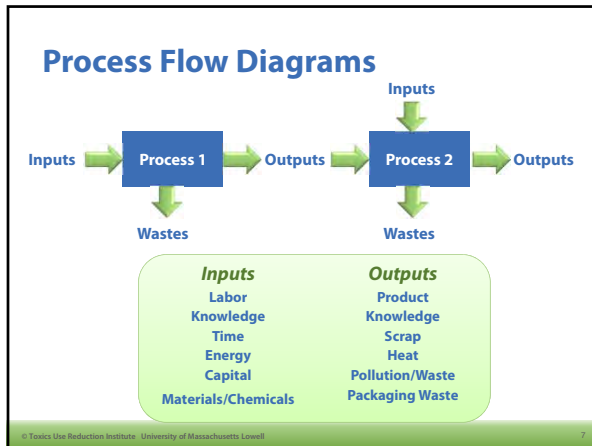

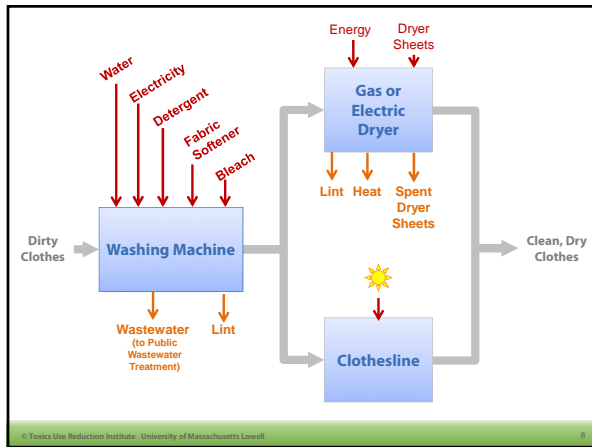

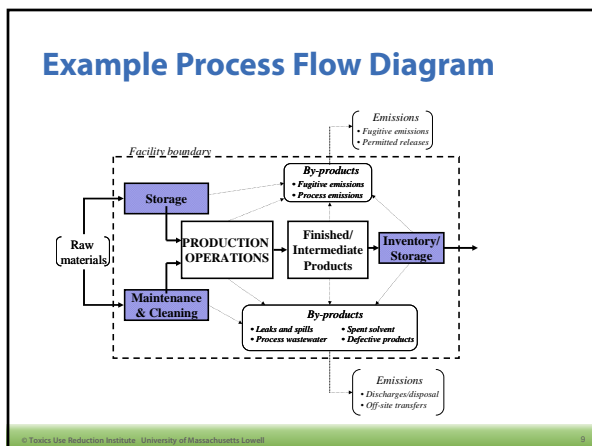

Why Use Process Flow Diagrams?



© Toxics Use Reduction Institute - University of Massachusetts Lowell 10

Why Not Just Use a Checklist?

Process flow diagrams allow you to see sequence and relationships --

- Increase understanding
- Improving decision-making

Important functional is sequence very!
Functional sequence is very important!

© Toxics Use Reduction Institute - University of Massachusetts Lowell 11

Chemical Pathway Analysis

- Identifies flow of specific chemicals (toxics), byproducts, or emissions, through processes**
- Traces flow of toxics through process flow diagram**
- Helps identify potential environmental emission points or safety problems**

© Toxics Use Reduction Institute - University of Massachusetts Lowell 12

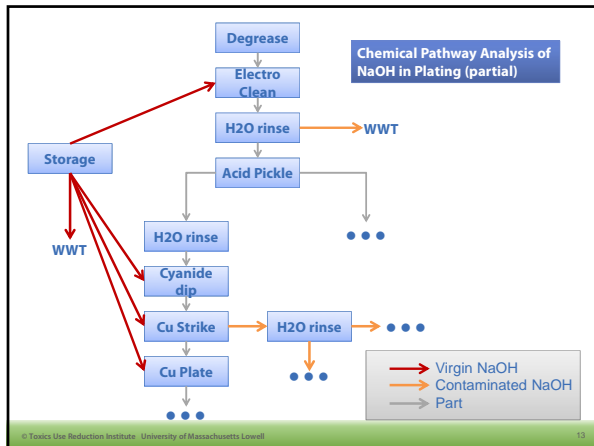

Unit of Product

A measure that reflects the *level of production* associated with use of toxic OR generation of toxic as a byproduct

Toxics use reduction should be normalized against the level of production to track progress

Select a measure of facility productivity that closely reflects activities involving toxics

© Toxics Use Reduction Institute - University of Massachusetts Lowell 14

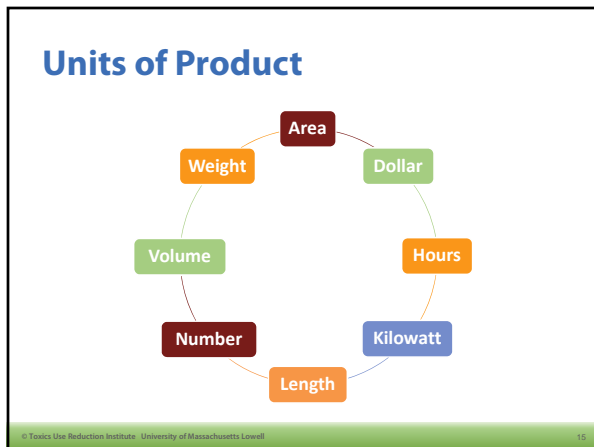

Creating a Process Flow Diagram (PFD)

Walk-Around:
Identify points where chemicals are entering or leaving process, such as:

- Fugitive, Point, and Area emissions to all media
- Byproduct flows to pollution control units such as:
 - Fume scrubbers
 - Wastewater treatment
 - On-site recycling
- Leaks, spills, evaporative losses, maintenance activities

© Toxics Use Reduction Institute - University of Massachusetts Lowell

16

Creating the PFD

Use Existing Data

- Operational data
- Piping diagrams
- Operating manuals
- Work flow diagrams
- Architect's plans

Do Not Re-Invent The Wheel !

© Toxics Use Reduction Institute - University of Massachusetts Lowell

17

Small Group Exercise (30 min)

- Acme Electronics
 - Read case information
 - Create PFD
- Discuss with large group



© Toxics Use Reduction Institute - University of Massachusetts Lowell

18

Use of Data in Planning

Compile data for current materials use and production processes

- Serves as baseline for all future TUR possibilities
- Provides comprehensive view of current work practices
- Indicates areas of high toxics use, or inefficiency

© Toxics Use Reduction Institute, University of Massachusetts Lowell

15

Almost all quality improvement comes via simplification of design, manufacturing...layout, processes, and procedures.

Tom Peters
In Search of Excellence





Process Characterization: Materials Accounting



© Toxics Use Reduction Institute, University of Massachusetts Lowell

What's Involved?

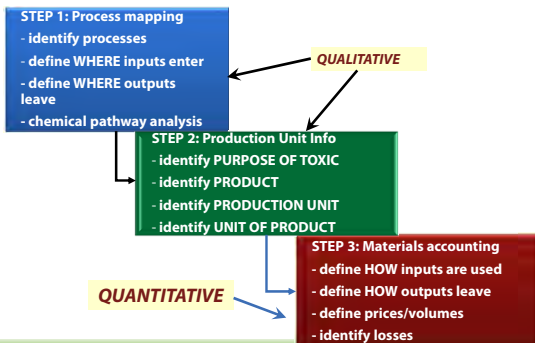

© Toxics Use Reduction Institute, University of Massachusetts Lowell

Process Characterization

For each toxic chemical used, identify and characterize:

- Purpose
- Total amounts and amounts per unit of product
- Byproduct fate: amounts released on-site, treated on-site and off-site, recycled on-site and off-site, and disposed of on-site and off-site
- Emissions to each media: amounts released on-site, disposed on-site, transferred off-site, and treated, recycled and disposed of off-site to air, surface water, ground water, and land
- Cost of toxics (qualitative or quantitative)
 - Quantitative if technically feasible options identified
 - Qualitative if no technically feasible options identified

© Toxics Use Reduction Institute, University of Massachusetts Lowell

Sources Of Chemical Use Data

Toxic Chemical Procurement (Purchasing)	Toxic Chemical as Inventory	Toxic Chemical Reuse/Recycling
<ul style="list-style-type: none">• Raw Material Purchasing Records• Vendor Invoices• Transfer Records (between facilities)	<ul style="list-style-type: none">• End-of-Year Inventory Records• Storage/Warehouse Records<ul style="list-style-type: none">• Potential source of Material Losses (e.g., leaks, evaporation, theft)• Production Run Data, Batch Tickets, etc.	<ul style="list-style-type: none">• Hauling / pickup records and manifests• Sales records (if byproduct being reused as product by another)

© Toxics Use Reduction Institute, University of Massachusetts Lowell

Byproducts Represent Inefficiency

Piped to onsite air, water, or waste treatment systems

Collected as hazardous or solid waste

Emitted directly to the air

Recovered and re-introduced into the production unit

Sold, traded, or entered into commerce

© Toxics Use Reduction Institute, University of Massachusetts Lowell

Emissions

Emissions: Byproducts that are released to the environment OR are transferred to an onsite or offsite management facility

Emissions = Total byproduct – quantity of byproduct destroyed in onsite treatment

Outputs to onsite treatment or recycling = Byproduct

Outputs to the environment from onsite treatment or recycling = Emission

Emissions include:

- Air (Point and Fugitive)
- Waste Water (to POTW, surface water, ground water, etc.)
- Surface water, ground water (storm drains)
- Hazardous and Solid Wastes sent to Waste Management Facilities
- Off-Site Recycling

© Toxics Use Reduction Institute, University of Massachusetts Lowell

Byproduct vs. Emissions

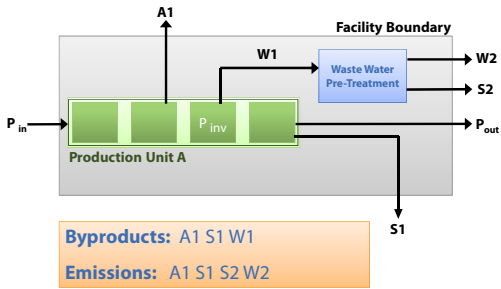

© Toxics Use Reduction Institute, University of Massachusetts Lowell

Byproduct and Emission Determination

Use Existing Data Sources

Direct Measurements -- continuous and non-continuous (extrapolations from periodic monitoring)

Engineering and Design Calculations

Best Engineering Judgment Estimates

Vendor specs and data

© Toxics Use Reduction Institute, University of Massachusetts Lowell

Data Sources: Byproducts and Emissions

Materials as Byproducts and Emissions

- Waste Transport Manifests and Invoices
- Media-specific Environmental Reports
- POTW, NPDES, Air Pollution Source Registration, Biennial Waste Reports
- Prior TRI Reports
- Spill/Release Reports

Materials Reused or Recycled

- Recycling Records:
 - Recycler Invoices
 - Recycling Permits
 - Scrap Logs

© Toxics Use Reduction Institute, University of Massachusetts Lowell

Plating Shop Example

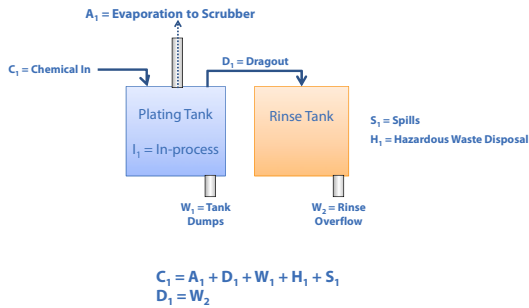

© Toxic Use Reduction Institute, University of Massachusetts Lowell

Plating Shop Pollution Prevention Options

- Prevent drag-out (reduce D_1)
- Use recovery technology* (return D_1 to process tank)
- Base tank dumps on tank analysis (reduce W_1 and H_1)
- Train operators to minimize spills (reduce S_1)
- Cover tank when not in use (reduce A_1)
- Implement preventative maintenance programs (reduce S_1)
 - * reverse osmosis, ion exchange or electrolytic recovery

© Toxic Use Reduction Institute, University of Massachusetts Lowell

Individual Exercises (30 min)

- We'll go through the following 5 examples of materials accounting calculations to check for understanding
 - Work through each individually and then have short group discussion
 - Finish up during lunch, if you'd like
- Solutions will be provided afterwards

© Toxic Use Reduction Institute, University of Massachusetts Lowell

Problem 1: Product impurity

Scrap tires are ground up to create crumb rubber, which is used as cushioning infill in artificial turf fields, as filler in paving material, as filler in molded and extruded products, and for a variety of other uses.

Sample testing of manufactured crumb rubber indicates that there is a concentration of 56 ppm of Lead (Pb) in the product.

- If 2000 tons of crumb rubber are produced in a year, how much Lead is processed?
- Does this amount need to be reported under TRI? (The reporting threshold for Lead is 100 lbs.)

© Toxics Use Reduction Institute, University of Massachusetts Lowell

Problem 2: Byproduct Calculation

Calculate the Total Byproduct and Emissions

Production Unit B is a vapor degrease operation. The company purchased 4,500 lbs of TCE to operate this production unit for one year. The fugitive emissions from the degreaser (A1) were determined to be 20% of the amount of TCE used in the degreaser. The fugitive emissions from the recycler (A2) were determined to be 5.0% of the TCE sent to the recycler. The spent TCE sent from the degreaser to the recycler was 10,000 lbs for the year. The recycling process recovered 80% of the TCE that was sent to it.

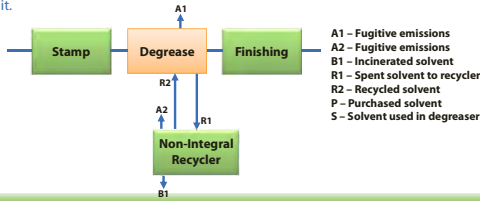

© Toxics Use Reduction Institute, University of Massachusetts Lowell

Problem 3: Back-Calculating Byproduct from Treatment Records

Calculate the annual byproduct generation of copper

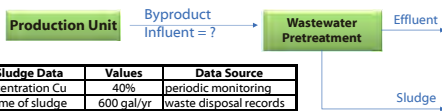

Sludge Data	Values	Data Source
concentration Cu	40%	periodic monitoring
volume of sludge	600 gal/yr	waste disposal records
density of sludge	30 lb/gal	lab results
Effluent Data		
Cu conc. in effluent	2.8 ppm	monitoring
avg flow of effluent	0.030 MGD	POTW flow meter

Assumptions

- Concentration by weight
- Volume includes all constituents, not just copper
- Production time is 255 days/year

© Toxics Use Reduction Institute, University of Massachusetts Lowell



Identifying TUR Opportunities



Class Exercise – Home Laundering

- Identify chemicals used in the process
- Brainstorm source reduction options
- Consider options in the following categories:
 - Input substitution
 - Product reformulation
 - Process redesign/modification/modernization
 - Improved operations and maintenance
 - Recycling

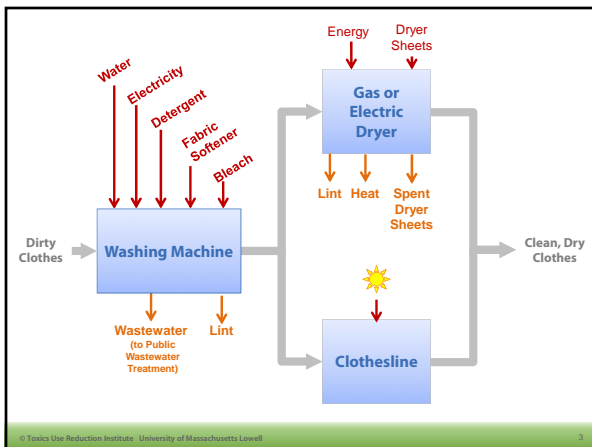

TUR Option ID and Evaluation Process

For *each* toxic in *each* production unit:

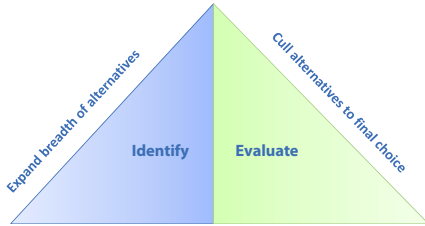

Introduction to Identifying TUR Options

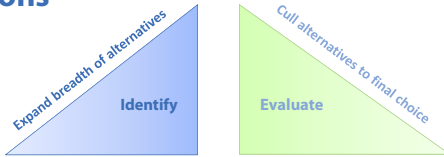

- Creative phase
- Generate complete list of TUR opportunities
 - Obvious opportunities
 - Hidden opportunities
- Costs / benefits

TUR Planning Team

- Who should be on the team
- When do you engage the various members of the team

- Create meeting agendas, including objectives of the meeting and anticipated next steps, to help ID who should be in the room

Six TUR Techniques

Input Substitution

Product Reformulation

Production Unit Redesign/Modification

Production Unit Modernization

Improved Operations and Maintenance

Recycling

1. Input Substitution

- Replacing a toxic or hazardous substance or raw material used in a production unit with a less toxic substance.

Examples:

- Substitute soy-based inks for petrochemical inks
- Substitute less toxic pigments for heavy metal pigments

Input substitution examples



Input Substitution

Replace chemical w/ less hazardous option

- May not reduce amount of waste, but waste is less hazardous
- Drop-in substitutes don't require process changes (and are rare)
- Some options may require equipment or product modifications

Requires careful analysis

Potential impact on product/process quality

2. Product Reformulation

- Reformulating or redesigning end products to be nontoxic or less toxic upon use, release or disposal

Examples:

- Decrease the amount of solvent needed to manufacture paint by switching to a high-solids formulation
- Introduce new product lines specifically designed to eliminate the use of toxic chemicals.

Product Reformulation

Involves product design and formulation stage

Typically results in less toxic chemical use in both process and final product

Meet consumer demand for environmentally conscious products

Comply with product content regulations

Product Reformulation examples



Product Reformulation

Invasive step

Must meet customer performance and quality specs

Revealing reformulation info may jeopardize competitive position

3. Production Unit Redesign or Modification

- Developing and using processes with different design than those currently used

Examples:

- Electrostatic paint spray or powder coating replaces solvent-based paint system
- UV-cured ink or pigment system to replace solvent-based method
- Replace solvent-based paint strippers with mechanical processes

Production Unit Redesign or Modification

Involves altering process used to make product

New way to manufacture

New equipment

New procedures

Production Unit Redesign Examples



Production Unit Redesign or Modification

Research success at other facilities

May require pilot runs

Affects employees

May involve additional capital costs

4. Production Unit Modernization

- Upgrading or replacing existing process equipment and methods with equipment and methods of a more recent design

Examples:

- Install countercurrent rinsing systems to reclaim process chemicals
- Use air knives to blow solutions back into baths
- Install precision metered fluid delivery devices in place of manual valves

Production Unit Modernization

Involves upgrading

- Replacing outdated equipment
- Replacing inefficient methods

Reduces toxic chemical use

Requires capital investment

Production Unit Modernization Examples

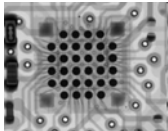

X-ray inspection – ball-grid array



Production Unit Modernization

Pays quickly

- Increased production
- Lower raw material use
- Lower waste disposal costs

Modernization includes

- Process control
- Automated control

Consider

- Down-time
- Capital availability
- Facility modifications
- Employee training

5. Improved Operations and Maintenance

- Improved housekeeping, system adjustments, product/process inspections, or process control equipment or methods

Examples:

- Institute employee training programs
- Install splash guards and drip boards
- Implement inventory control program to prevent expiration of chemicals

Improved Operation and Maintenance

Cost effective

May involve:

Changing operating procedures

Operator training

Preventive maintenance programs

Improving inventory management and control

Improved O&M examples



Improved Operation and Maintenance

"Real" procedures may differ from management's understanding

Production workers may resist change if it results in more work

6. Recycling

- Recycling, reuse, or extended use of toxics by using equipment or methods which are integral to the process, including filtration and other closed loop methods

Examples:

- Capture and recycle cleaning solvents
- Regeneration of acid instead of disposal of acid
- Recycle and reuse spent rinse water
- Distill and reuse solvent strippers

Non-integral vs integral recycling

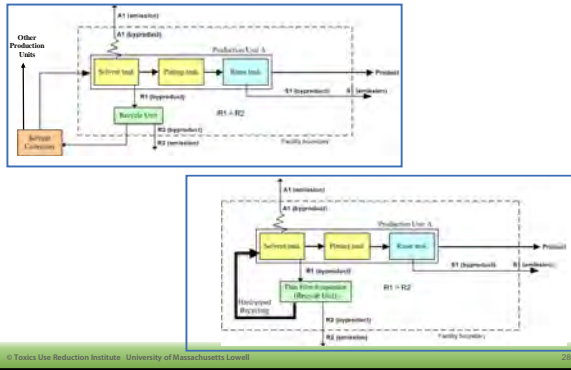

Integral Recycling examples

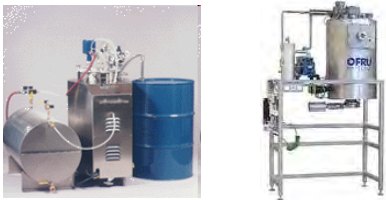

In Process Recycling

“Closed-loop” recycling and reuse

Reduces annual amount purchased and discharged

Often a cost-effective and economically feasible option

Sources for Identifying Options

-  Safer alternatives technical resources
-  Trade associations
-  Industry trade journals
-  Vendors
-  Technical expert in similar companies
-  State or other government technical assistance, information or research resources



SUBS PORT
Substitution Support Portal

MOVING TOWARDS SAFER ALTERNATIVES

Case story database
You can use the free text search function to find information in the case story database. Use the search filters to refine your search.
Please enter your search text or numerical substance identifier

100-94-5

Search filters
Sector
All

[+ More search filters](#)

Items per page
10 25 50

[Search Database](#)

2 Result(s) in EN 0 Ergebnis(se) auf DE 0 Resultat(s) en FR 0 Resultado(s) en ES 0 Risultati na SR

Assessment, development and demonstration of alternatives for a propyl bromide Alternatives to Toxic, VOC, Ozone Depleting and Global Warming Energized Electrical Equipment Cleaners

Small Group Activity (15 min)

- Brainstorm TUR options for Acme Electronics (use worksheet)
- Time permitting, research other options on-line using suggested sources
- Large group discussion



Be Systematic

Identify process, toxic chemical and TUR technique

- Use multiple resources
- Be creative

Assure the option:

- Results in a reduction in toxics use
- Is technically feasible

Consider if implementing the option could:

- Create process concerns
- Raise employee H&S concerns
- Create potential environmental impacts
- Cause additional regulatory burden

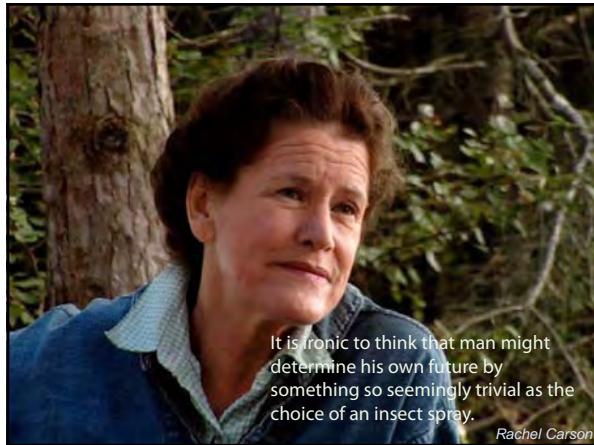

It is ironic to think that man might determine his own future by something so seemingly trivial as the choice of an insect spray.

Rachel Carson



TUR Options Evaluation and Alternatives Assessment



© Toxic Use Reduction Institute, University of Massachusetts Lowell

TUR Option ID and Evaluation Process

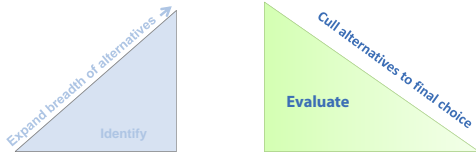

Eliminate Options

- Technically infeasible
- Not TUR

Evaluate Remaining Options

- Technical evaluation
- EH&S evaluation
- Economic evaluation

© Toxic Use Reduction Institute, University of Massachusetts Lowell

Screening TUR Options



3

Apply Screening Criteria

Avoid the “bad actors”

- Carcinogens, highly flammable liquids, PBTs, etc

Key performance criteria

- Customer specifications
- Processing needs

Availability of alternative materials or technologies

Do not screen out based on economic factors lightly

© Toxics Use Reduction Institute - University of Massachusetts Lowell

4

Assessing Input Substitution Options

In order to determine if a substitute is safer you need to first fully characterize the toxic chemical you'd like to replace

For input substitution, characterize potential alternatives and compare to the toxic

Eliminate any options that are not safer

Consider trade-offs of substitution

© Toxics Use Reduction Institute - University of Massachusetts Lowell

5

What is a “Safer Alternative”?

A different, less toxic chemical that achieves the same, or better, results

An alternative material, product or process that eliminates the need for using the chemical of concern

Re-design or reformulation of a product that eliminates need for a process or material requiring toxic chemical

New technologies and knowledge lead to innovative even more ‘safer’ alternatives

© Toxics Use Reduction Institute - University of Massachusetts Lowell

6

Safer Alternatives Process

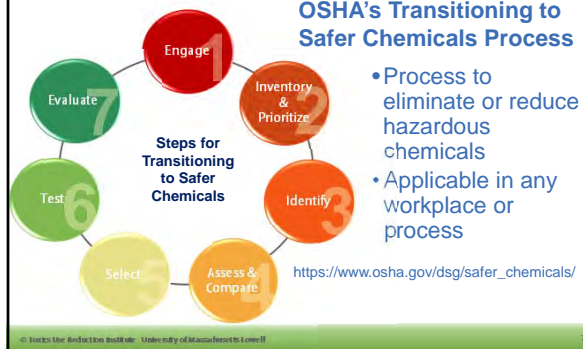

Safety Data Sheet

1. Identification
2. Hazard(s) identification
3. Composition/information on ingredients
4. First aid measures
5. Firefighting measures
6. Accidental release measures
7. Handling and storage
8. Exposure control/personal protection
9. Physical and chemical properties
10. Stability and reactivity
11. Toxicological information
12. Ecological information
13. Disposal considerations
14. Transport information
15. Regulatory information
16. Other information

© Toxics Use Reduction Institute - University of Massachusetts Lowell

Valuable Information in SDS

- Identification of hazardous chemical ingredients and percentage in products
- Specifies health hazards and potential symptoms of exposure
- Recommends how to reduce exposure risks
- Informs on regulatory restrictions

© Toxics Use Reduction Institute - University of Massachusetts Lowell

How can this chemical affect my health?

Stronger effect / evidence Weaker effect / evidence

■ **Acute (Short Term) Effects** How do we know?

- Toxic to Humans & Animals** – Can be fatal on contact, ingestion or inhalation for humans and other mammals.
- Irritates the Eyes** – Can cause irritation or serious damage to the eyes.
- Irritates the Skin** – Can cause irritation or serious damage to the skin.

■ **Chronic (Long Term) Effects** How do we know?

- Cancer** – Can cause or increase the risk of cancer.
- Birth Defects** – Can cause harm to the developing child including birth defects, low birth weight and biological or behavioral problems that appear as the child grows.
- Reproductive Harm** – Can disrupt the male or female reproductive systems, changing sexual development, behavior or functions, decreasing fertility, or resulting in loss of the fetus during pregnancy.
- Other Health Effects** – Can cause serious damage on contact or ingestion.
- Asthma Trigger** – Can result in high sensitivity so that small quantities trigger asthma, nose or sinus inflammation or other allergic reactions in the respiratory system.
- Brain/Nervous System Harm** – Can cause damage to the nervous system including the brain.
- PBT (Persistent Bioaccumulative Toxicant)** – Does not break down readily from natural processes, accumulates in organisms concentrating as it moves up the food chain, and is harmful in small quantities.

Data sources:

Cancer

US Dept of Health & Human Services
Report on Carcinogens
Reasonably Anticipated to be Human Carcinogen

MAK Commission of Germany (Deutsche Forschungsgemeinschaft)
List of Substances with MAK & BAT Values & Comments
Carcinogen Group 2 - Considered to be carcinogenic for man

US Environmental Protection Agency
Risk Management Action & TSCA Draft Plans
Possible carcinogen - TSCA Criteria met

Birth Defects

US Dept of Health & Human Services
Expert Panel Reports & Monographs on Reproductive and Developmental Toxicity
A-Clear evidence of adverse developmental toxicant effects

State of California Environmental Protection Agency
Chemicals Known or Suspected of Causing Cancer or Reproductive Toxicity: California Proposition 65 List (Selected) (Wilmington) (June 2016) (1606)
Developmental toxicity

European Commission
Substances with CLP Risk & Subst. Hazard (Commission proposal) (2015/016)
R63: Possible risk of harm to the unborn child.

Reproductive Harm

US Dept of Health & Human Services
Expert Panel Reports & Monographs on Reproductive and Developmental Toxicity

Small Group Activity (15 min)

- Use SDS for a flux remover to identify
 - Ingredients of the formulation
 - Related hazards
 - Health effects (Acute /immediate, Chronic)
 - Most dangerous routes of exposure
 - Precautions for working with a methylene chloride stripper
 - Any physical characteristics of the stripper that might affect exposure
- Based on what you have learned from the SDS, would you recommend continued use of this flux remover?

© Toxics Use Reduction Institute - University of Massachusetts Lowell 15

Small Group Activity Part 2 (15 min)

With your group, use ChemHAT to continue your assessment of the flux remover

- What additional information did you learn from ChemHAT?
- Has your assessment of the flux remover changed?

Evaluating Chemical Substitutes

Identify substitutes that will perform comparably and are unlikely to be cost prohibitive

Select substitute most likely to result in long-term option (avoid cost of repeat analysis)

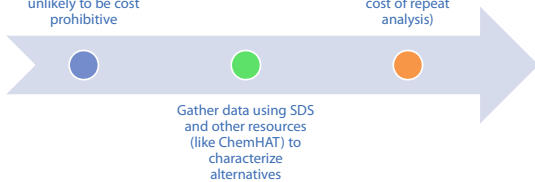

TURI's Library Guide for EH&S Data Resources

TURI - Toxics Use Reduction Institute

Home Library > Research > Environmental, Health and Safety Data Resources

Environmental, Health and Safety Data Resources

This guide has been created to assist in researching environmental, health and safety information for chemicals

Last Updated: Mar 4, 2014 | URL: <http://guides.turi.org/toxics/index.php> | 25 Print Guide | 2688 Updates

Home Health Safety Environmental Regulatory/Conventional/NEP Sustainable Futures Alternatives Other Resources

- Authoritative sources for chemical hazard data
- Regulatory drivers
- Tools, databases and models
- Go to: <http://guides.turi.org/index.php>
 - EH&S data resources option on left hand box

Assessing Performance Potential

- What function does targeted hazardous chemical play in your company's product, process or service?
- Do potential alternatives adequately replace the functional performance of that hazardous chemical?



Technical Evaluation

Availability –
equipment and
materials

- "Off-the-Shelf"?
- Requires custom development?

Source reduction?

- Does it really reduce toxics?
- Avoids shifting risks?

Effects on product
quality

- Meets customer/market demands?
- Product durability?

Other Impacts

- Worker retraining required?
- Operational efficiency impacts?

Example: Process Re-Design

Wood furniture factory makes process change to eliminate methylene chloride adhesive

- Major change required testing, significant time
- Stronger bond with water-based adhesive
- Increased productivity with heat to reduce drying time



Example: System Change

Plastic pallets allow cheaper transportation, but pose fire threat without toxic chemical flame retardant



- Alternative flame retardants fail strength, weight needs
- Can revert to wood pallets, or
- Make system change with more protective warehouse fire control systems to eliminate need for flame retardants



Courtesy of Pure Strategies, 2015

© Toxics Use Reduction Institute - University of Massachusetts Lowell

What is “Technically Infeasible?”

Equipment	<ul style="list-style-type: none">• Not available• Cannot be developed• Too risky
Workers	<ul style="list-style-type: none">• Inadequate skills readily available
Product quality	<ul style="list-style-type: none">• Change would render quality unacceptable• Downstream quality impact / workflow disruption• Change would slow production time
Regulatory	<ul style="list-style-type: none">• Impacts ability to meet other regs• Unacceptable increase in regulatory burden
Facility	<ul style="list-style-type: none">• Not enough floor space• Insufficient utilities or infrastructure (e.g., compressed air)

© Toxics Use Reduction Institute - University of Massachusetts Lowell

23

Economic Screening

Factors include:

- Does not meet company's investment criteria
- Clearly too expensive
- Credit not available for investment

Do not to eliminate options too quickly

© Toxics Use Reduction Institute - University of Massachusetts Lowell

24

Example: Process Re-Design

- Cost factors in adopting water-based adhesive process
 - While water-based adhesive costs more per gallon than methylene chloride adhesive, higher solids content of water-based adhesive resulted in lower volume used, net cost savings
 - Energy cost of heat required to cure water-based adhesives compensated for by faster drying, increased throughput
 - Operational savings paid for capital costs in short term, provided greater long-term profitability

Assessing Costs

Types of costs to consider in evaluation of options

- Operating costs/savings
 - Material costs
 - Efficiency costs/improvements
 - Regulatory costs
- Capital costs
 - Initial investment in structures, equipment, etc.
 - Payback period (if operational savings)
- Labor costs/savings
 - Additional training, new hires for needed skills, etc.
 - Increased productivity, reduced absenteeism after elimination of hazardous chemical
 - Reduced liability risks
- Non-tangible benefits
 - Improved company image, sales

Costing a System Change



Capital Costs vs. Lifecycle Costs

Cumulative Flooring Costs

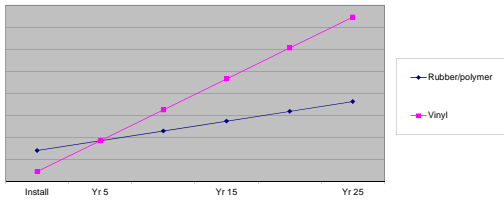

Courtesy of Pure Strategies, 2015

Small Group Activity (30 min) – Performance and Cost

- Using the TUR options for reducing the use of nPB flux remover identified by the team, consider the following:
 - Key performance criteria
 - Who you would confer with/include in this step
 - Where would you find needed information
 - What options would you consider for further evaluation
- Use the cost information provided to assess the cost implications of adopting your preferred option

Factors Limiting Adoption of Safer Alternatives

- Lack of worker or management awareness of health impacts
- Weak regulations/lack of regulatory drivers for change
- Efficiency of currently-used processes and materials
- Familiarity with current materials and processes
- Cost of alternatives materials or new equipment
- Inadequate/uncertain availability of alternatives

Pilot Test Preferred Option

- Identify potential unknown issues
 - Quality
 - Impact on other processes
 - Worker health & safety issues
 - Regulatory impacts
- Gather appropriate data
- Tweak process accordingly
- This will help in making the business case for change

Possible strategic business priorities

Increased profit = reduced costs + increased revenue	Demonstrate leadership in: <ul style="list-style-type: none">• Price• Quality• Technology• Customer response
Increase market share	Address parent company goals
Achieve greater productivity/operational efficiency	Reduce GHG/Carbon footprint
Faster time-to-market	Enhance resource (energy and water) efficiency
Improve public image	Avoid liabilities/Regulatory impacts
Develop breakthrough products or services	

Link EHS activities to company strategy

When the EHS project generates recognized business value....
.....your voice in the company changes!

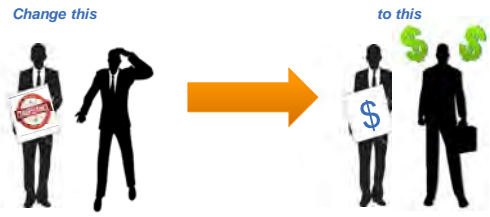

Features	<ul style="list-style-type: none"> • Aqueous cleaner in place of chlorinated solvent
Advantages	<ul style="list-style-type: none"> • Far less toxic
Benefits	<ul style="list-style-type: none"> • Reduced risk • Reduced costs of PPE, ventilation, insurance, haz waste mgmt, permitting, etc. • Improved worker safety – improved labor relations • Improved PR • Market advantage of “green” operations

© Toxics Use Reduction Institute · University of Massachusetts Lowell

34

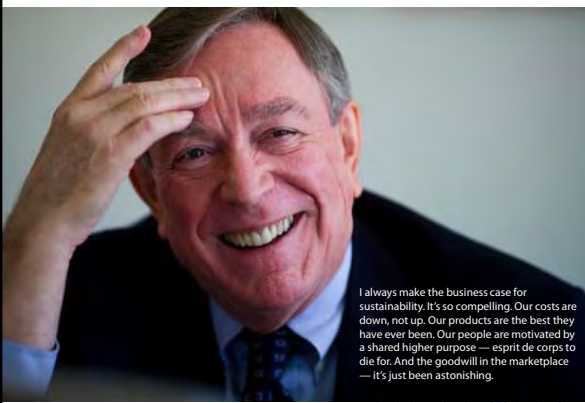

I always make the business case for sustainability. It's so compelling. Our costs are down, not up. Our products are the best they have ever been. Our people are motivated by a shared higher purpose — esprit de corps to die for. And the goodwill in the marketplace — it's just been astonishing.

Ray Anderson, founder & CEO, Interface Carpet

Agenda: Toxics Use Reduction to Achieve Enhanced Pollution Prevention

Michigan Department of Environmental Quality, August 20, 2015

Topic	Description	Approx Timing	Objectives
<p style="text-align: center;">1</p> <p>Introduction to Toxics Use Reduction</p>	<p>What is Toxics Use Reduction (TUR)?</p> <hr/> <p>Pollution Prevention vs Pollution Control</p> <hr/> <p>Pollution Prevention Hierarchy</p> <hr/> <p>Toxics Use Reduction Techniques</p> <hr/> <p>Historical Context for TUR</p> <hr/> <p>1970s - Pollution Control and cleanup</p> <hr/> <p>1980s - Crisis Management, Liability, and Toxics</p> <hr/> <p>1990s - Pollution Prevention</p> <hr/> <p>2000s - Emphasis on Management Systems and Higher Hazard Substances</p> <hr/> <p>TUR and Planning</p> <hr/> <p>Group Discussion: How can Continual Improvement be Built into the Planning Process?</p>	45 min	<ul style="list-style-type: none"> • Discuss the evolution and context for toxics use reduction (TUR) • Understand the central role of planning in achieving TUR • Differentiate between TUR, pollution prevention and pollution control, and understand why the differences are important • Identify TUR techniques, and discuss examples of how they can be implemented • Make connection to Michigan's green chemistry initiatives
<p style="text-align: center;">2</p> <p>Process Characterization: Process Mapping</p>	<p>Introduction to Process Characterization</p> <hr/> <p>Engaging with the Right Team</p> <hr/> <p>Process Mapping</p> <hr/> <p>Chemical Pathway Analysis</p> <hr/> <p>Defining the Unit of Product</p> <hr/> <p>Using Existing Process Maps</p> <hr/> <p>Conducting a Walk-around</p> <hr/> <p>Small Group Exercise: Creating a Process Flow Diagram for Acme Electronics</p>	60 min	<ul style="list-style-type: none"> • Develop a visual representation of a production process • Assess a production process and determine the best way to divide it up into production units • Conduct a chemical pathway analysis of process • Understand units of product and their role in normalizing toxics use • Learn how to create pictorial representation of where toxics enter and leave processes
<i>Break</i>		15 min	

Agenda: Toxics Use Reduction to Achieve Enhanced Pollution Prevention

Michigan Department of Environmental Quality, August 20, 2015

Topic	Description	Approx Timing	Objectives and Exercises
3 Process Characterization: Materials Accounting	Quantitative Analysis Byproducts and Emissions Sources of Data/Information Mass Balances Materials Accounting Techniques Individual Exercises: Various Materials Accounting Scenarios	90 min	<ul style="list-style-type: none"> • Determine how to assess materials use in a process • Identify appropriate units of product • Differentiate between byproduct and emission • Demonstrate and practice mass balance and materials accounting techniques • Describe how to do an inventory of toxic chemical use and account for all of the toxic chemicals used
LUNCH		60 min	
4 Identifying TUR Options	Engaging with a Team Toxics Use Reduction Techniques Sources of Information Small Group Activity: Identifying Options at Acme Electronics Being Systematic	90 min	<ul style="list-style-type: none"> • Understand why it is important to generate a range of TUR options • Learn tools and methods to help you generate TUR options
5 TUR Options Evaluation and Alternatives Assessment	Screening out Options Assessing Chemical Substitutions Safer Alternatives Assessment Process Gathering Data on Chemicals Small Group Exercise: Characterizing Flux Remover at Acme Electronics Evaluating Technical Feasibility Evaluating Economic Feasibility Small Group Exercise: Performance and Cost Evaluation of TUR Options at Acme Electronics Pilot Testing The Business Case for Implementation	90 min	<ul style="list-style-type: none"> • Consider technical, environmental and human health and safety, and economic criteria when assessing the feasibility of TUR options • Develop appropriate screening procedures for potential TUR options • Conduct appropriately thorough evaluations of options, including assessment of safer chemical alternatives • Develop systematic procedures for choosing TUR options to implement.
Wrap up	Group Discussion: How can you bring TUR into your P2 technical assistance activities?	30 min	<ul style="list-style-type: none"> • Clarifying questions • Class Evaluation